

**universal<sup>®</sup>**  
*sport*

The Universe of Sports



**TENNIS SPORT +  
BALLSPORT 2024**  
ENGLISH EDITION



## Advantage UNIVERSAL SPORT

Dear tennis and sports fans,

Universal Sport has been represented on the national and international market for more than 40 years. We are one of the largest suppliers of tennis and sports equipment in the world and are continuously expanding our global market position.

We place a particular focus on our own production of aluminium and steel products „Made in Schöniach“. Many other items from our extensive range are manufactured in Germany - look out for the „Made in Germany“ seal, the logo of our own brand „Court Royal“ and all certified products with the TÜV-GS seal.

Our presence at international tournaments is unbeatable proof of our professionalism we are.

You will find our new products on page 1 of this 2024/25 catalogue, followed by all the important products for the trend sports of padel tennis and pickleball from the USA. From accessories to turnkey systems, everything is represented. Here too, quality is of course our top priority.

Our legendary ability to deliver and the first-class service associated with this is due to the fact that we purchase and produce in advance at the end of each season.

The Universal Sport team is highly motivated and happy to support you with all your orders and questions at any time.

Should you require individual advice or are interested in customised products, we are always happy to help you personally.

Our daily parcel and forwarding service as well as our direct sales at our head office enable us to offer you first-class purchasing conditions.

You will find changing special offers and highlights in our web shop.

I wish you a good, healthy start to the new season and every success.



Managing Director / CEO Managing Director  
Universal Sport GmbH



### Our own brands



Tennis and sports equipment



Info systems



Kid's tennis



Universal Sport GmbH  
Waldstraße 8  
D- 71101 Schoenaich

Tel. +49(0)7031 7533-0  
Fax +49(0)7031 7533-33  
info@universal-sport.com  
www.universal-sport.com

### Our exclusive and trade brands



Ball throwing machines

air-ennis.com

Ball wall systems



The Sports Machine Company

Ball throwing machines



Tennis balls





Info on page 29

### Motorised roller USP two-part New Generation

The USP tennis court rollers in proven design and quality with new panelling, further improved. With two-part roller body with equalising differential for better turning of the roller.  
No. 40136



Info on page 55

### Fantastic aluminium bench with 4 seats

This modular system allows for an enormous variety of club colours. The frame is made of natural aluminium and is equipped with a sturdy cross strut. The bench is UV-resistant and absolutely weatherproof thanks to the water drainage on the seat shells. The bench is easy to transport thanks to its low weight. Screws for fastening and cover caps are included.  
Height: 900 cm Width: 450 cm Length: 1960 cm  
No. 41221



Info on page 67



### Universal Flex grandstand with 24 seats,

**indoor and outdoor** with castors  
• Flexible grandstand construction made of aluminium  
• Can be screwed together as a kit  
• Approx. dimensions: L 4.0 m x D 2.0 m x H 1.10 m  
• with polyamide transport rollers for easy moving of the stand  
• 24 individual seats  
• Choice of RAL colours  
No. 40988

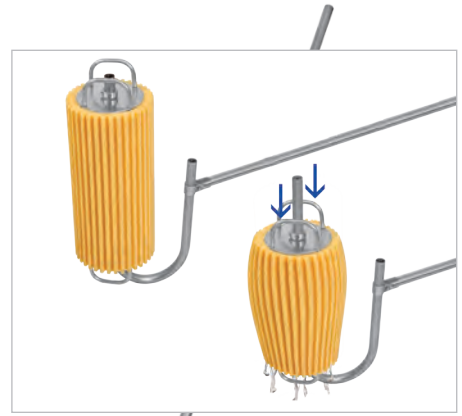

Info on page 25

### Sponge roller

Innovative maintenance tool that removes puddles of water from the tennis court in the shortest possible time. Thanks to the specially designed surface structure, the sponge roller has an enormous suction volume. In addition, sand or other materials do not stick. Suitable for brick dust, quartz sand or hard court surfaces.  
No 41185



**NO TWISTING  
NO BUCKLING**

### Water hose SMARTFLEX SMT Comfort

55-ply PVC quality hose, UV and ozone resistant, free from algae formation, phthalate-free, high-strength polyester yarn with patented SMT Steady Mesh Technology that actively prevents the hose from twisting.  
No. 41372 25 m 3/4"  
No. 41373 50 m 3/4"  
No. 41375 25 m 1"  
No. 41376 50 m 1"

Info on page 27

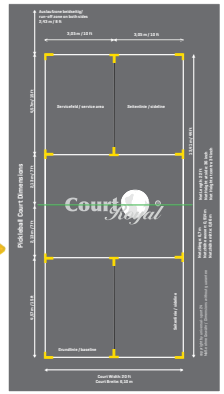
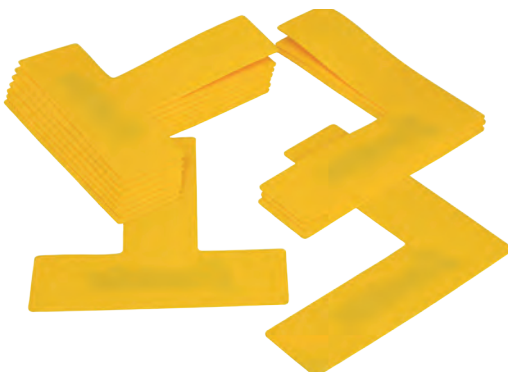

### Floor marking set Pickleball

Consisting of: 4 x L pieces and 8 x T pieces. This allows you to quickly set up a clearly visible pickleball court and play straight away. Further accessories such as mobile equipment and bats/balls can be found from page 5 onwards.  
No. 46043



## Pickleball Court Dimensions

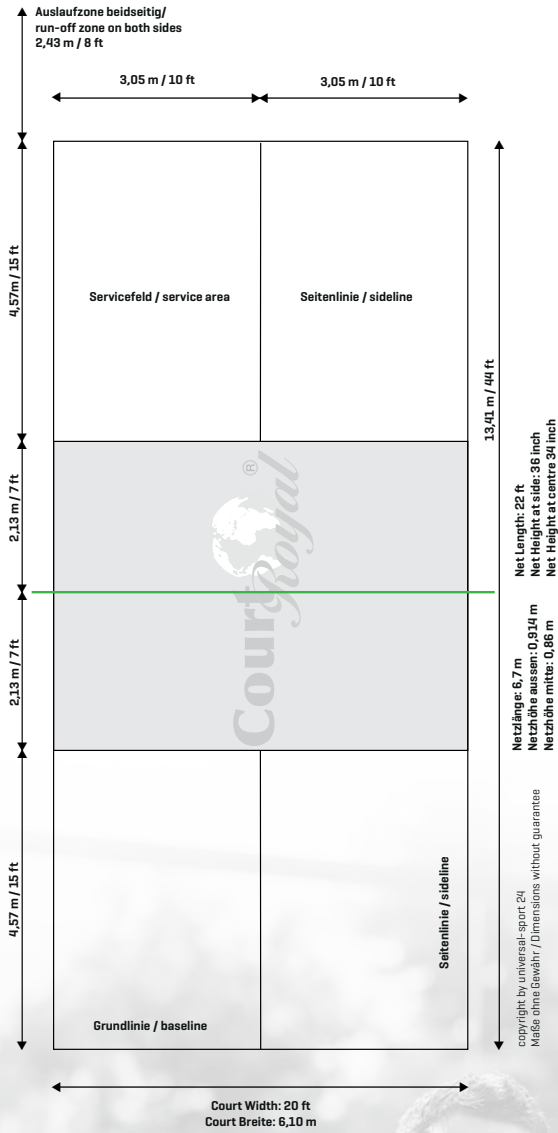

## Padel Tennis Court Dimensions

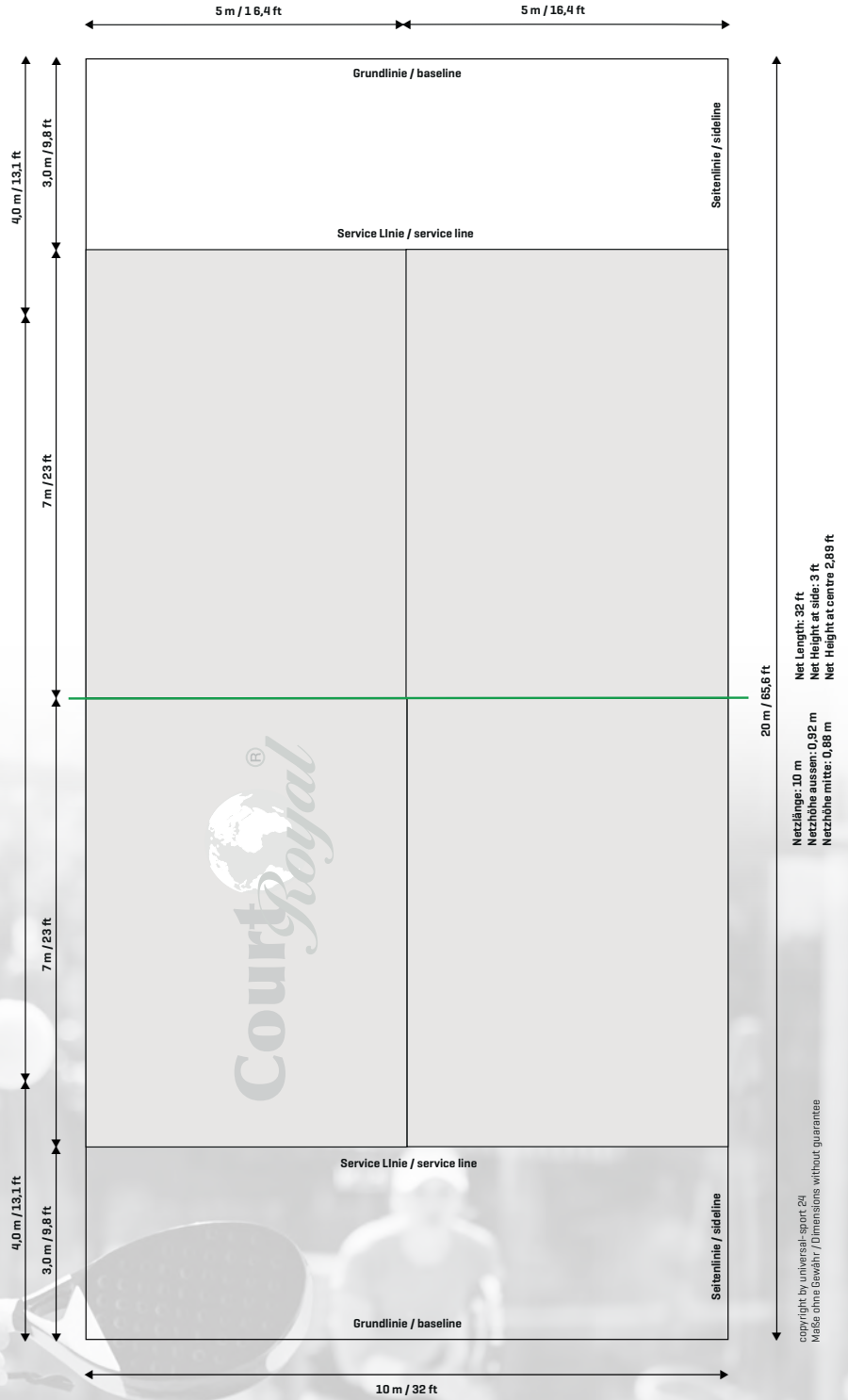

<b>Keyword Index</b>	<b>Page</b>	<b>3</b>
<b>Pickleball // Padel Tennis</b>	<b>Page</b>	<b>4 - 9</b>
Pickleball net systems / rackets / balls / posts / nets / ball throwing machine / court dimensions Padel tennis - complete systems / net posts / nets / brooms / balls / court dimensions Ball throwing machines		
<b>Maintenance + Care</b>	<b>Page</b>	<b>11 - 29</b>
Brick dustbins / broomsticks / wheelbarrows / shovels / rakes / scrapers Drag mats / drag nets / line sweepers / equipment holders / site drying / site sprinkling Motorised rollers / motorised brooms		
<b>Nets + Accessories</b>	<b>Page</b>	<b>30 - 43</b>
Court Royal tennis nets / Court Royal tennis net posts / Webbing straps / Net anchors Ground anchors / Net supports / Post tensioning mechanism / Spare parts Mobile tournament net systems / Court dimensions		
<b>Tennis Court Accessories</b>	<b>Page</b>	<b>44 - 67</b>
Marking tapes / Line cover / Special tennis lines + accessories / Line roller / Line tamper Signs / scoreboards / match pointers / referee chairs / advertising benches / parasols Benches shoe cleaners / litter bins / information boxes / screens / Pitch divider nets / Stand seats / Stands		
<b>Training Walls + Ball Machines</b>	<b>Page</b>	<b>68 - 74</b>
AIR-Tennis / Smash-Back practice wall / Tennis tutor Ball throwing machine Ball throwing machine Tennis-Twist / Playmate ball throwing machine / net training walls		
<b>Training + Equipment</b>	<b>Page</b>	<b>75 - 82</b>
Ball baskets / ball trolleys / ball collectors / hurdles / coordination ladder / marking aids Medicine balls / multisport radar / foam balls / skipping ropes / tennis balls / training aids		
<b>Kid's Tennis</b>	<b>Page</b>	<b>83 - 88</b>
Children's tennis balls Stage 1-3 / Tennis rackets Stage 1-5 / BIMBI net systems / Net system sets Ground markings for small court tennis		
<b>Ball Sports + Equipment</b>	<b>Page</b>	<b>89 - 104</b>
Volleyball posts / Beach volleyball posts / Referee platforms / Court markings Badminton posts / Volleyball nets / Badminton nets / Football tennis / Football youth goals Handball goals / Training goals / Basketball facilities / Basketball baskets / Basketball goal boards Streeball facilities / Scorli LED scoreboard		
<b>Court Dimensions</b>	<b>Page</b>	<b>5, 8, 39, 108</b>



ARTICLE	PAGE	ARTICLE	PAGE	ARTICLE	PAGE
Absorbing Roller Special	25	Information Board	102, 103, 104	Sprinkler	26
Advertising Bench	54	Iso-Line	46	Stabilizing Bracket for Basketball	93
Advertising Screen	60, 61	Jowo Tennis Caddy	78	Stage Balls	84
Advertising Umpire`s Chair	53			Stage Rackets	84
Air Tennis	69	Line Brush	22, 23	Stage Lines	87
Aluminum Brick powder distributor	14	Line Lightening Sweeper	15	Standard Dividing Net	62, 37
Aluminum Multi-Purpose Shovel	13	Line Master	15	Steel Wire Broom	12, 21
Aluminum Plow	15	Line Roller	48	Streetball	101
Aluminum Scraper	15	Line Stamper	48	Streetball Backboard	100, 101
Aluminum Surface Profile Blade	13	Lines	46, 47	Support Rod	41, 43
		Line Blitz	23		
Badminton	92, 93			Tennis Ball Catcher	76
Balls	5, 9, 73, 82, 84	Manual Roller	28	Tennis Balls	73, 82, 84
Ball Back	69, 70, 74	Marking Cone	81	Tennis Benches	54, 55, 56, 57
Ball Basket	99, 101	Marking Line	46, 47	Tennis Caddy	78
Ball Caddy	77, 78	Marking Lines for Children`s Tennis	88	Tennis Court Drying Set	25
Ball Collector	76, 77	Marking Strips	1, 87	Tennis Court Reservation Clock	49
Ball Machine Padel	9	Marking Trolley	86	Tennis Lines	46, 47
Ball Machine Pickleball	7	Match Liner	23	Tennis Net	31, 32, 33, 34, 35
Ball Mover	73	Match Pointer	50, 51	Tennis Net Post	36, 37, 38
Ball Pickup Tube	77	Match Timer	49	Tennis Net System	42, 43
Ball Throwing Machine	7, 9, 71, 72, 73	Mid Court Tennis Net	85, 86, 87, 88	Tennis Court Broom	20, 21
Basketball	98, 99, 100, 101	Motor Roller	29	Tennis Court Number	51
Basketball Backboard	100			Tensioning Screw	41
Beach Volleyball	91, 94	Net	5, 9, 31, 32, 33, 34, 35, 67, 93, 94	Training Aid	80, 81, 82
Benches	54, 55, 56, 57	Net Post	6, 8, 36, 37, 38, 42	Training Wall	69, 70, 74
Bimbi Children`s Tennis	84, 85, 86, 87, 88	Net Rod	41, 43	Tribune	66, 67
Brick Sand Boxes	12	Numbers	49	Tribune Seats	64, 65
Brick Sand Distributor	28			Turbo Broom	12
Broom	8, 17, 20, 21, 63	Padel Balls Unlimited	9	Tutor Ballmachines	7, 9, 71, 72, 73
		Padel Court Royal	8	Tubular Anchor	41
Center Strap	6, 9, 40, 41	Paper Basket	59		
Children`s Net System	85, 86, 87, 88	Part and Full-Circle Sprinkler	26	Universal Absorbing Roller Special	25
Children`s Racket	84	Playmate Ballmachine	72, 73	Universal Bench Court Royal	55
Circular Sprinkler	26	Plow	7	Universal Sports Post	6, 8, 36, 37, 38, 42
Clax Ball Trolley	77	Practice Wall	69, 70, 74		
Coconut Smoothing Mat	17	Padel Tennis	8, 9	Volleyball	90, 91, 94
Collapsible Tennis Post	43	Pickleball	5, 6, 7	Waste Bin	59
Combination Leveler	16, 17			Water Roller	25
Coordination Ladder	80	Rake	15	Wheelbarrow	13
Court Dimensions	2, 7, 10, 105, 106	Ranking List	49	Wind Screen	60, 15
Court Royal Tennis Nets	31, 32, 33, 34, 35	Ratchet Tensioner	47	Wire Waste Bin	59
Court Side Bench	54, 55, 56, 57	Referee Chair	52, 53, 91, 92	Wooden Handle	14
		Replacement Marking Strips	46		
Dividing and Stop Net	62, 63	Rolldry	25		
Drag Cord	19	Rubber Rake	14		
Drag Net	16, 18, 19	Rubber Squeegee	14		
Drag Net Material	19				
Drain Cleaner	14	Sand Spreader	28		
		School Tennis	84, 85, 86, 87, 88		
Equipment Holder	24	Scoreboard	102, 103		
		Seats	53, 64, 65		
Fitness Dumbell	82	Shoe Cleaner	58		
Fixing Clamp	47	Shoe Cleaning Tub	58		
Folding tripod	26	Shovel	13		
Frankfurt Shovel	13	Showcase	104		
		Sign for Court Rules	49		
Geka Adapters	27	Single Net Rods	41, 42		
Granulate Broom	8, 20, 21, 63	Small Court Tennis Net	85, 86, 87, 88		
Granu-Top	20	Smash Back	74		
Ground Sleeves	6, 8, 36, 37, 39, 90, 92	Smoothing Mat	16		
		Soccer	95, 96		
Hand Brush	20	Softball, yellow	79		
Hand Brush Holder	14	Spare Parts for Tennis Net Posts	39		
Hand Leveler	12	Special Rake	7		
Handball Goal	97	Special Adapters	43		
Handle Holders	24	Special Smoothing Mat for Silica	16		
Handles	14	Speed Trac Sports Radar	76		
Hose	27	Speziala Lines	47		
		Spray Nozzle	27		



### Pickleball net system Court Royal

The mobile pickleball net system is a German quality product manufactured in-house. High-quality aluminium profiles and wide feet for stability and sturdiness. Quick and easy assembly thanks to plug-in aluminium connecting elements. Ideal net tension thanks to the net tensioning system. Net height is guaranteed by the centre pole. The system complies with U.S.A.P.A. and DPB specifications. Complete with net. Dimensions 670 cm x 86.5 cm, weight 6.8 kg  
 No. 404231

### Pickleball net system Replacement net

With side insertion flaps, 670 x 80 cm  
 No. 404238



### Pickleball net system Court Royal Professional

This newly developed pickleball net system is an absolute novelty from our own production. A professional Court Royal model. The extra heavy transportable net system is made of an aluminium frame and ensures an optimal and secure stand with the heavy steel weight plates and the aluminium cross struts. The posts have an internal trapezoidal tensioning mechanism for easy tensioning of the net. A device is integrated in the centre of the net system to adjust the net to the optimum height using a webbing strap. With standard dimensions of 670 x 86.5 cm, the system is suitable for tournaments. Black powder-coated, complete dimensions of the system: approx. 681 x 93 cm. Without net.  
 No. 404233



### Yoorna Tinia 2.0

The Tinia 2.0 is the ideal beginner's model in the pickleball sport. It has a rounded shape and is made of wood with a weight of approx. 300 grams +/- 15 grams. The high-quality handle sits perfectly in the hand. The handle has a circumference of approx. 10 cm and a length of 13 cm. The attached edge protection protects the racket from wear and tear. Due to its weight, it provides sufficient power, especially for beginners with little effort. The racket complies with USAPA specifications and is suitable for all DPB tournaments.  
 No. 404240



### Belt strap II T

Für transportable Netzanlagen. Aus Nylon, mit Verstellerschlaufen, aber ohne Karabinerhaken.  
 No. 407101



### Pickleball GAMMA 3er Set outdoor

With 40 holes for a safe and precise flight. Approved as a tournament ball according to the official list of USA Pickleball and IFP Pickleball. Weight per ball: approx. 20 g  
 Colour: neon yellow  
 No. 404252



### Pickleball GAMMA 3er Set indoor

With 26 holes for a safe and precise flight. Approved as a tournament ball according to the official list of USA Pickleball and IFP Pickleball. Weight per ball: approx. 20 g  
 Colour: neon green  
 No. 404250





### Pickleball Net PN 5

Made of approx. 3 mm polyethylene braided rope, hand-knotted, black, knotted inside, very sturdy plastic double net border, complete with plastic-coated steel rope. Side and bottom edges with heavy, black plastic edging, as well as two 10 mm thick glass fiber rods for lateral fixation. Long life and best durability. 3 years factory warranty on the net.  
Dimensions: 660 x 80 cm, Mesh size: 4,5 cm  
No. 404230

### Pickleball post aluminium PP 73 with base plate

The plastic-coated aluminium posts with plate, manufactured in-house, are an absolute novelty on the pickleball market. The height of 91 cm above the ground with base plate, as specified by the association, is guaranteed. For this reason, these posts are suitable for competitions. With a diameter of 73 mm and a special three-chamber profile, this is a first-class product. The tried-and-tested screw-on aluminium gear mechanism ensures optimum net tension. All net holding poles, screws and hooks are made of VA steel.  
A special feature of these posts are the steel base plates, which can be attached to a concrete slab with dowels.  
No. 404224 black

### Pickleball Post Alu BH 73

Ausführung rund  $\varnothing$  73 mm aus kunststoffbeschichtetem Aluminium drei Kammern Spezialprofil, sehr stabil mit anschraubbarer Alu-Zahnradmechanik. Netzhaltestangen, sämtliche Schrauben und Haken aus VA Stahl. Zum Einbau in den Boden. Lieferung ohne Bodenhülsen. Gesamtlänge: 125 cm, über Boden: 90 cm  
No. 404222 grün  
No. 404223 schwarz

### Ground Sleeves 73

Ground sleeves for 73  $\varnothing$  mm post  
No. 404281



### Center Strap III

With plastic snap lock, spring hook and Velcro strip.  
No. 40720

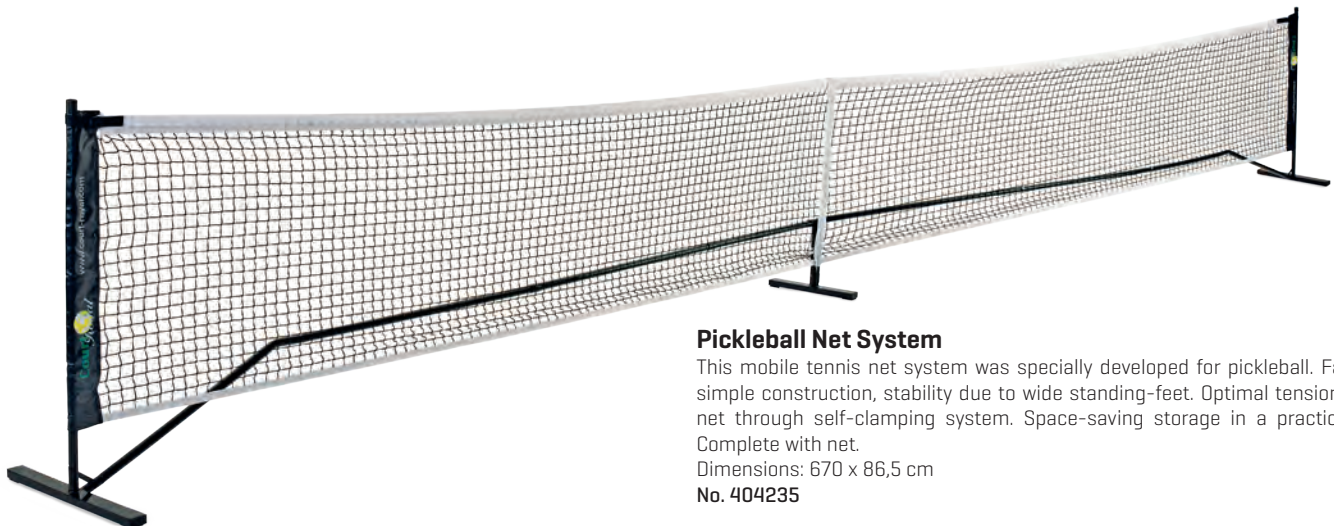

### Pickleball Net System

This mobile tennis net system was specially developed for pickleball. Fast and simple construction, stability due to wide standing-feet. Optimal tension of the net through self-clamping system. Space-saving storage in a practical bag. Complete with net.  
Dimensions: 670 x 86,5 cm  
No. 404235

### Pickleball Net System Replacement Net

With side pockets 670 x 80 cm  
No. 404238



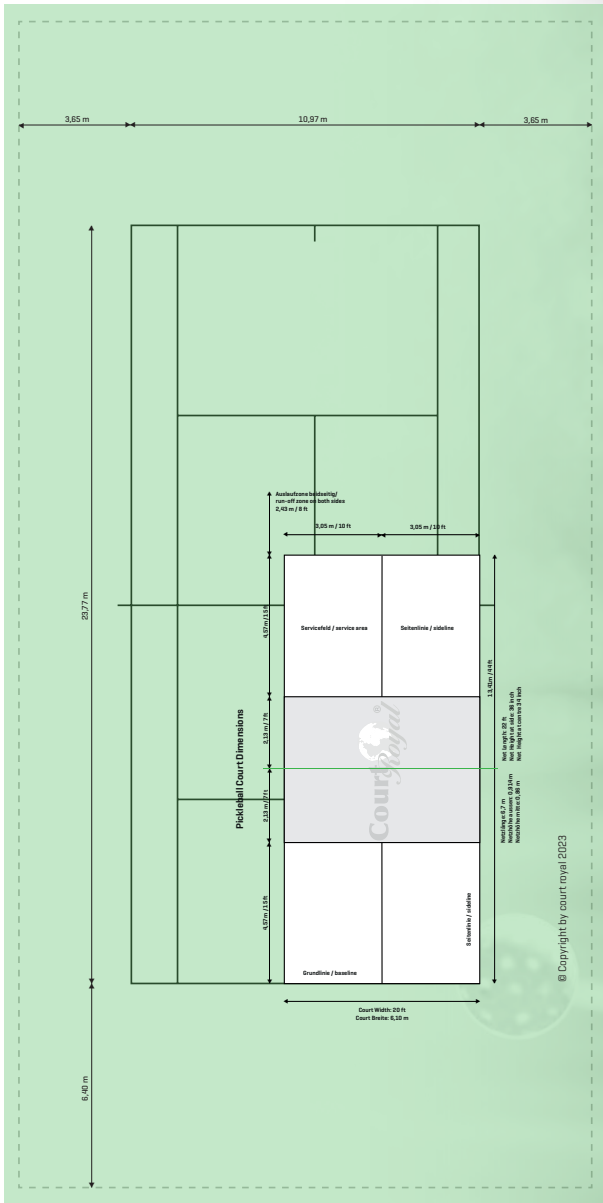

Space required for pickleball court compared to tennis tournament court

## Ball Machine Pickleball Tutor Mini

The new ball thrower is a novelty and was designed specifically for pickleball. Fully equipped and incredibly user friendly. The compact design with 38 x 33 x 30 cm paired with a low weight of around 11 kg allows optimal transport. With the manual height control, a feed from groundstroke to lob is easily possible. Imposing ball speeds of up to approx. 80 Km/h cover every need. A regular ball sequence can be set individually between 2 and 10 seconds. Dynamic training is provided by an oscillator, which distributes the balls variably over the playing field. Great capacity of up to approx. 60 outdoor or indoor balls. Built-in rechargeable battery allows up to approximately three hours of play time per charge.

### Technical details:

Ball capacity:	appr. 60 Balls
Dimensions (HxWxD):	38 x 33 x 30 cm
Weight (with battery):	ca. 11 kg
Power:	battery
Playing time:	2 - 3 hours
Recharging time:	12 Std.
Feeding interval:	2-10 sec.
Top speed:	appr. 80 km/h
Ball flight:	manually adjustable (lob/round shot)
Line-directions:	one direction and randomly
Ball type:	indoor and outdoor
Housing:	plastic
Remote control:	none, on-off switch

No. 404270





## PADEL COURT ROYAL

### Complete system ready to play

Complete system 10x20m for indoor and outdoor. Complies with the regulations of the German Padel Federation (DPB) and the International Padel Federation (FIP). Construction according to EN 10219 with hot-dip galvanized steel and thermosetting polyester paint. All screws made of stainless steel. Tempered safety glass according to EU standard with 10 mm and quality rubber seals. Advance artificial grass with quartz sand filling and lining available in various colors. Adjustable paddle net with posts. Two entrances in WPT design with a width of 100 cm. In addition, the Court can be equipped with four floodlight poles with LED spotlights (not included in delivery). A solid ground is required for the construction of a foundation. For outdoor a strip foundation with permeable asphalt is recommended.

No. 40646

### Padel Court Royal Portabel Single

Mobile Kompletanlage mit 6x20m für InMobile complete system with 6x20m for indoor and outdoor. No fixed foundation is needed for this system. The System is mounted on a portable kit with frame made of steel pipe girders all around.

No drilling into the ground is required.

No. 407471

### Padel Court Royal Portabel

Mobile complete system with 10x20m for indoor and outdoor. No fixed foundation is needed for this system. The System is mounted on a portable kit with frame made of steel pipe girders all around. No drilling into the ground is required.

No. 40747



### Padel Tennis Netpost PP 73 with plate

Round design  $\varnothing$  73 mm made of plastic-coated aluminium three-chamber special profile, very stable with screw-on aluminium gear mechanism. Net holding rods and all screws and hooks made of VA steel. With base plate for fixing to the concrete slab with dowels.

Length above ground: 92 cm

No. 40636

### Padel Tennis Netpost PP 73 BH

Round design  $\varnothing$  73 mm made of plastic-coated aluminium three-chamber special profile, very stable with screw-on aluminium gear mechanism. Net holding rods and all screws and hooks made of VA steel. For installation in the ground, supplied without ground sockets.

Total length: 125 cm, above ground: 92 cm

No. 406351

### Ground Sleeves 73

Ground sleeves for 73  $\varnothing$  mm post

No. 404281



### Padel court broom plastic yellow

50 cm wide, with 3 interchangeable broom sections on an aluminium base frame. Complete with three-part, very sturdy aluminium drawbar and mountable net deflectors. The ideal maintenance broom for synthetic turf surfaces filled with quartz sand. Plastic bristles, yellow, angled

No. 408811

### Replacement broom plastic yellow

No. 40883



### Padel Tutor Plus ball throwing machine

The Tennis Tutor Padel is a battery-operated ball throwing machine specially designed for padel balls. With its compact dimensions of 51x50x51 cm and a weight of only 21.6 kg, it is ideal for transporting. Thanks to the extendable handle and wheels, the machine can be pulled as a trolley. The ball speed can be customised from a slow ball to a high-speed ball with a brilliant 136 km/h. The trajectory can be varied between net roll and lob, a regular ball sequence or a random scattering angle in 1.5-10 seconds. The practical, fold-out ball container holds approx. 150 balls. With a battery life of 4-6 hours, extensive training is easily possible without interruptions to recharge the ball throwing machine.

#### Technical data:

Capacity:	approx. 150 balls
Dimensions:	(height x width x depth) 51 x 50 x 51 cm [closed]
Weight:	[with battery] 21.6 kg
Power connection:	Battery operation [charging current 230 V]
Battery life:	4 - 6 hrs.
Charging time:	12 hours
Ball sequence:	1.5 - 10 sec.
Maximum speed:	136 km/h
Flight path :	short - long adjustable
Ball type:	topspin, spin, flat, slice
Spreading angle:	1 direction and random
Housing:	Plastic
Remote control	wireless on/off

No. 40640



### Padel Balls unlimited

The combination of a robust rubber core with a high-quality felt layer meets the special requirements of padel play. Good ball control and a precise point of impact are guaranteed. Compared to tennis balls, the internal pressure is reduced. Weight: approx. 56 g..

No. 40638 3 ball tin

No. 40637 4 ball tin



### Padel Tennis Net PN 8

Made of approx. 3 mm high-strength polypropylene, black, PES net binding. Complete with plastic-coated steel cable.

Dimensions: 1000 x 92 cm, mesh size 4.5 cm

No. 40630



### Padel Tennis Net PN 9

Very sturdy plastic double net surround, complete with plastic-coated steel cable. Sides and lower edges with heavy, black plastic edging and two 10 mm thick fibreglass rods for lateral fixation. Long service life and optimum durability. 3-year factory guarantee on the net.

Dimensions: 1000 x 92 cm, mesh size 4.5 cm

No. 40631



### Center Strap III

With plastic snap lock, spring hook and Velcro strip.

No. 40720

### Padelcourt screen Digimash

4 C digital print.

With silver-coloured eyelets every 50 cm.

Dimensions: 1850 mm x 900 mm

Delivery incl. snap hook

No. 41526 one-sided print

No. 41527 double-sided print





## Maintenance + Care



The Universe of Sports

## Turbo broom USP 10

The USP 10 turbo broom makes it easier for you to remove the old brick dust in spring. Thanks to its low weight, the broom is easy to move. The V-belt drive enables left/right movement, so even the corners of the tennis court can be removed cleanly. The USP 10 turbo broom is very versatile. For example, it can also be used for clearing leaves and snow from paths and car parks.



Controlling the direction of rotation



Height adjustment



Engine control unit

### Technical data:

Engine:	Honda four-stroke engine approx. 5 hp. Normal petrol
Traction drive:	by hand
Sweeping brush drive:	V-belt drive left/right
Working width:	approx. 90 cm
Tyres:	Balloon tyres
Weight:	88 kg
Time required per square:	approx. 40 min.

No. 40161

### Accessories:

- No. 40165 PVC brush ring, double white
- No. 40164 PVC/steel brush ring
- No. 40162 Swath former



### Brick Sand Boxes

Composite of glass fibre plastic and synthetic resin, resulting in high inherent stability. The material is UV-resistant and protected from all weather conditions. Iron parts made of stainless steel, each brick flour box is equipped with a hinged lid. Delivery colour: grey/orange

No. 41290	700 kg	550 Ltr.	134 x 99 x 78 cm	Stück €	940,00
No. 41300	1100 kg	700 Ltr.	134 x 99 x 96 cm	Stück €	1.177,00
No. 41301	1100 kg*	700 Ltr.	134 x 99 x 96 cm	Stück €	1.240,00
No. 41310	1500 kg	1100 Ltr.	63 x 121 x 101 cm	Stück €	1.860,00
No. 41312	2200 kg*	1500 Ltr.	184 x 143 x 104 cm	Stück €	2.550,00

\*] Material removal at bottom



### Wheelbarrow Standard

Capacity: 85 l, 240 kg. Galvanized barrow with beaded rim, 1 pneumatic tire 400 x 100 mm with nylon sleeve bearing.  
No. 40103

### Wheelbarrow Universal 100 l

Capacity: 100 l. Seamless pressed, galvanized barrow with sturdy rounded rim, 2 pneumatic tires, load 300 kg.  
No. 401021



### Wheelbarrow Court Royal

This newly developed wheelbarrow for tennis sand should not be missed on any tennis court. Capacity 250 l, polyethylene synthetic bottom, 6 mm wall thickness, allround stable rim, break proof, high abrasion resistance and complete UV-stability, stable 1" tubular steel frame, phosphated and plastic-coated, reinforcing cross-bars for stable bottom, simple emptying via tube runners, ball bearings air tyres with pneumatic wheels, size 400 x 80 mm, load-carrying capacity 350 kg.  
No. 401025



### Aluminum Multi-Purpose Shovel

To spread clay or to remove old material and leaves, complete with handle.  
No. 40101                      Size: 380 x 380 mm  
No. 40100                      Size: 370 x 270 mm



### Frankfurt Shovel 1]

Round shovel made of steel, painted red, oil-hardened with ashwood handle.  
No. 40099

### Holstein Shovel 2]

Square shovel made of steel, painted red, oil-hardened with ashwood handle.  
No. 40098

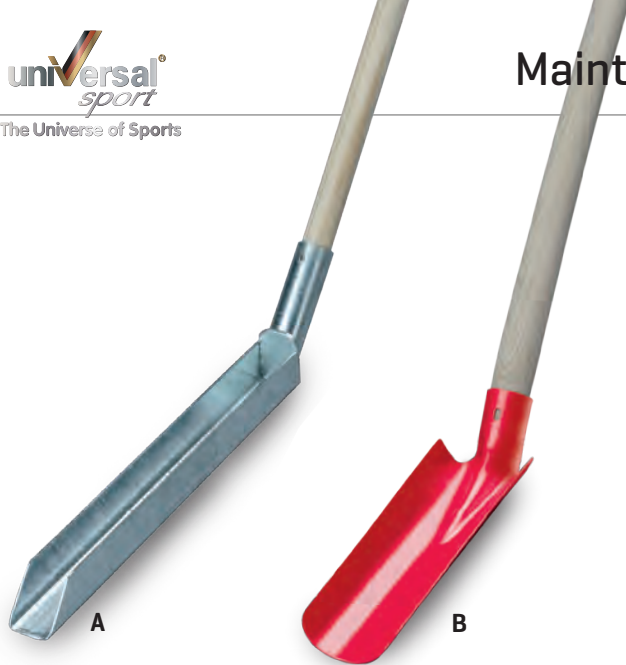

### Drain Cleaner A

To clean drain gutters. 5 cm wide, complete with wooden handle.  
No. 40030

### Gutter cleaner B

Made of aluminum, collapsible, light construction, simple to handle. An essential tool for the groundkeeper for checking levels and finding hollows. Length 10 cm.  
No. 40033



### Hand Leveler

Made of aluminum, with rubber blade. To wash in the top covering and clear puddles, 200 cm wide.

No. 40020

Spare rubber blade for hand leveler

No. 40021



### Rubber Rakes

For fast removal of leaves and rubbish, without handle.

No. 40090 50 cm wide

No. 40089 70 cm wide

**Wooden Handle Ø 28 mm** for Rubber Rakes.

No. 40094

Alle Preise verstehen sich inkl. gesetzlicher MwSt..

### Broom handle for hand broom ROYAL

Made of aluminium, Ø 22 mm, length 1.20 m [see page 22]\*.

No. 411133

### Broom handle for hand broom ROYAL

Made of wood, Ø 23 mm, length 1.46 m [see page 22]\*.

No. 411132

### Broom handle 28 mm

Made of wood, Ø 28 mm straight. Length 1.5 m. For brick dust spreader, aluminium ceiling profile blade, brick dust scraper, double smoother, special scraper, moss cutter, scraper, aluminium scraper rail, rubber rake.

No. 40094

### Broom handle 24 mm

Made of wood, Ø 24 mm straight. Length 1.5 m. For line flash, matchliner, line broom, hand broom.\*

No. 40091

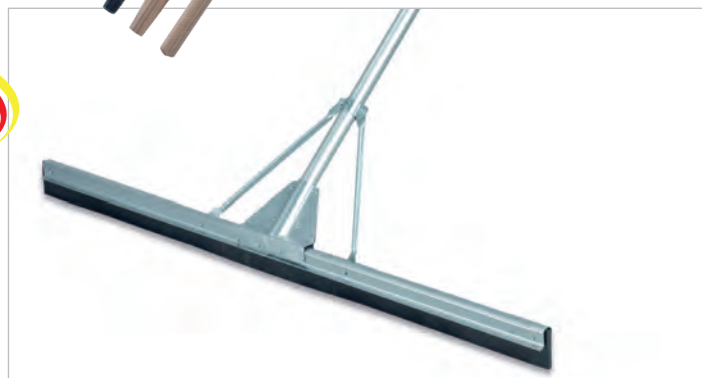

### Rubber Squeegee

Steel bar with rubber blade. Specially intended for stone removal. Light leveling of loose courts and water removal on hard surfaces, 100 cm wide, handle included.

No. 40022



### Aluminium Brick Sand Distributor

To fill in holes and level irregularities, 100 cm wide, without handle.

No. 40060

### Wooden Handle Ø 28 mm

for Rubber Rakes.

No. 40094





**Wooden Sharrier** Triangular beech wood, 70 cm wide with saw blade, without handle.

No. 40040

**Wooden Sharrier**

as above, though without saw blade.

No. 40042

**Saw Blade** for wooden rake.

No. 40051

**Wooden Handle Ø 28 mm**

No. 40094



**Aluminum Sharrier**

One side with steel band saw blade, the other side with solid profile, 70 cm wide.

No. 40050

**Saw Blade** for plow

No. 40051

**Wooden Handle Ø 28 mm**

No. 40094



**Aluminum Surface Profile Blade**

To smooth out irregularities, without handle.

No. 40080 80 cm wide

No. 40081 150 cm wide

**Wooden Handle Ø 28 mm**

No. 40094

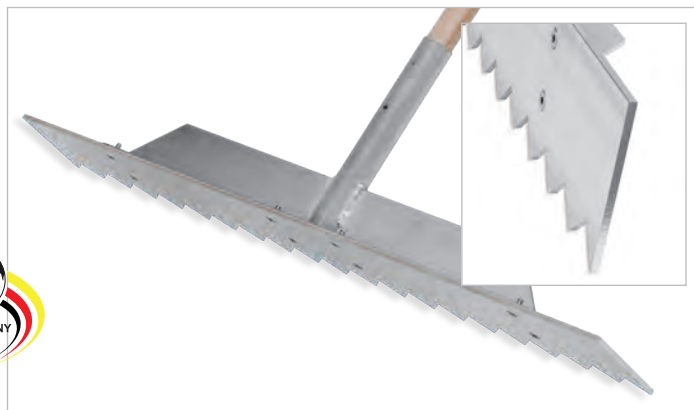

**Aluminum Scraper**

Double-sided tool, one side toothed to roughen surface, other side flat for spreading. 80 cm wide, without handle.

No. 40070

**Wooden Handle Ø 28 mm**

No. 40094

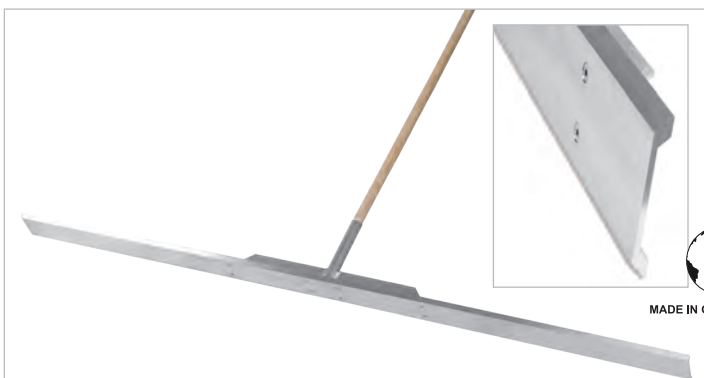

**Dressing Spreader**

Trapezoidal shaped aluminum section dressing spreader. Light and easy to handle yet robust for precise distribution of material over large areas, 200 cm wide, without handle.

No. 40084

**Wooden Handle Ø 28 mm**

No. 40094



**Special Rake**

Made of stainless steel, corrosion-resistant, for professional smoothing of clay courts, 66 cm wide, without handle.

No. 40083

**Wooden Handle Ø 28 mm**

No. 40094

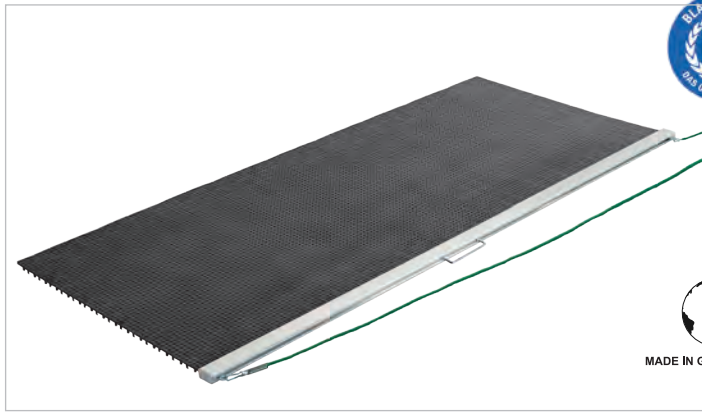

## Hard PE Smoothing Mat

The newly developed Universal Sport aluminum profile perfects the long-standing concept of the drag mat hard PE and combiplaner. Due to the 15 x 20 cm individual segments a maximum flexibility of the whole application is given. The manifold scratch elements at the bottom side are ideal for roughening the place and at the same time for smoothing the unevenness and cleaning from leaves without damaging the surface. Especially suited for Cannada -Tennis, artificial grass courts and clay courts. All used material is extremely weather resistant and low wear. Dimensions: 185 x 75 cm  
No. 41070

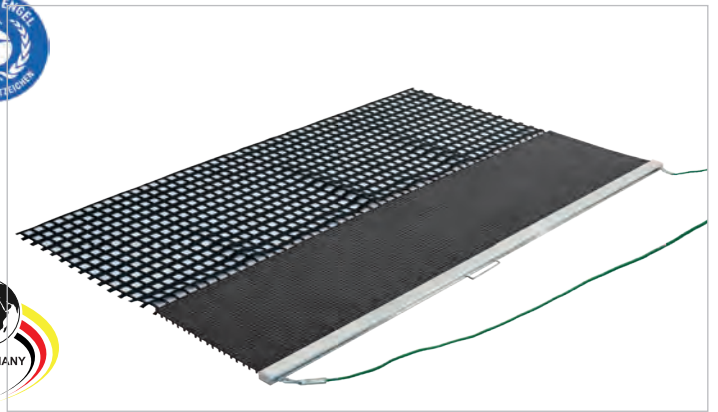

## Combination Leveler

The newly developed Universal Sport aluminum profile perfects the long-standing concept of the drag mat hard PVC and combiplaner. This special tool combines the advantages of the drag mat Hard PVC and that of a drag net. The PVC front part opens and clears unevennesses and with the rear part of the heavy drag net the open places are smoothed again and scratched filth gets dragged along. All used material is extremely weather-resistant and low-wear. Working width: 185 cm  
No. 41079

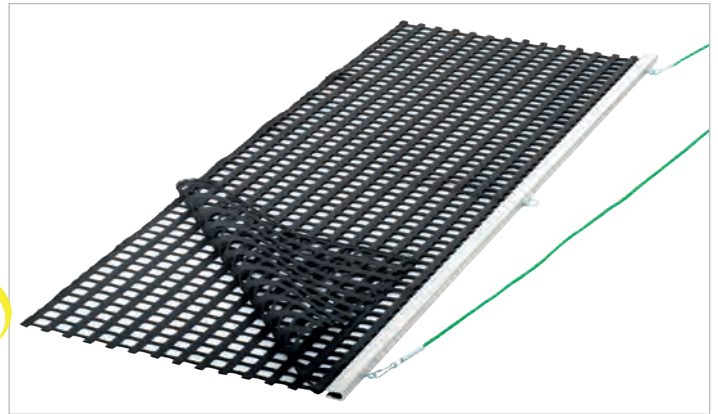
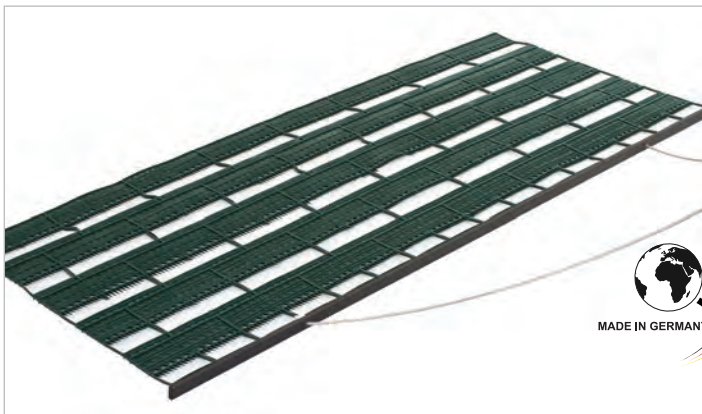
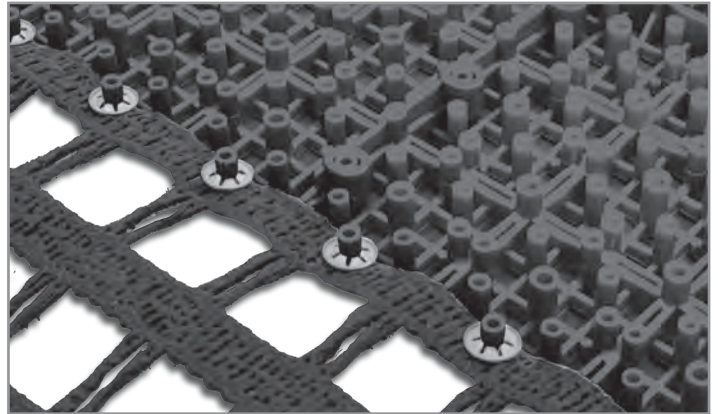

## Smoothing Mat Super Clean

This mat was developed to remove foliage, leaves, pine needles, etc. in an effective and quick way. This is possible through the smoothing with the Super Clean drag net which leads to excellent court leveling. After the smoothing a shaking out of the net outside the court is sufficient. The net should be kept flat on the ground while using. Dimensions: 230 x 66 cm. Includes aluminum rail with drag cord.  
No. 41077

Alle Preise verstehen sich inkl. gesetzlicher MwSt..

## Uniplan 75

Heavy aluminum pull rod to level the tennis court surface, special PVC fabric extra, double. Working width 190 cm. Net depth 75 cm with pull rope.  
No. 410309



### Broom-Mat Platzfit 150

Combination broom and mat. Consists of a broom with plastic bristles and PVC drag net. Aluminum rail and handle.

No. 41071 working width 150 cm

### Replacement Brushes 150 cm

No. 410712

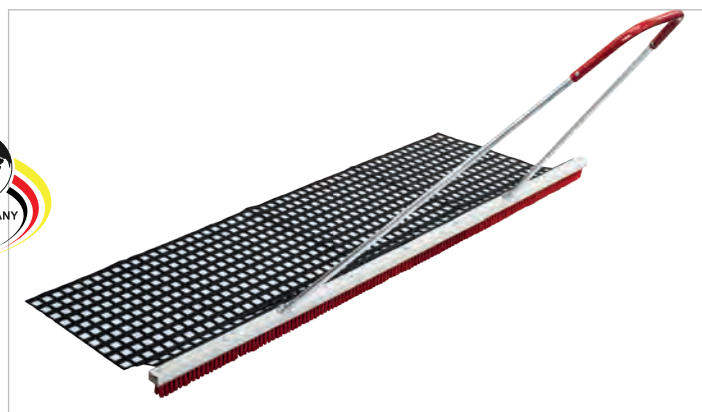

### Broom-Mat Platzfit 200

Combination broom and mat. Consists of a broom with plastic bristles and PVC drag net. Aluminum rail and handle.

No. 41072 working width 200 cm

### Replacement Brushes 200 cm

No. 410710



### Combined Broom

The new Combination broom and net. The top court equipment for clay and granular courts. Consists of a plastic/Arenga broom and PVC special net. Aluminum rail and handle.

No. 41073 working width 200 cm

### Replacement Brushes 50 cm

No. 40936



### Combined Hand Leveler

Combination hand leveler and drag net. The ideal tool for smoothing courts after sprinkling or rainfall. Due to the rubber blade and the drag net two operations are done in half the time. Fills unevenness and smoothes the court surface.

No. 41078 working width 200 cm



### Coconut Smoothing Mat

Heavy-duty coconut mat with PVC edges 200 x 100 cm. Wooden rail with drag cord.

No. 41060

### Replacement Smoothing Mat

Size 200 x 100 cm

No. 41050

Alle Preise verstehen sich inkl. gesetzlicher MwSt.

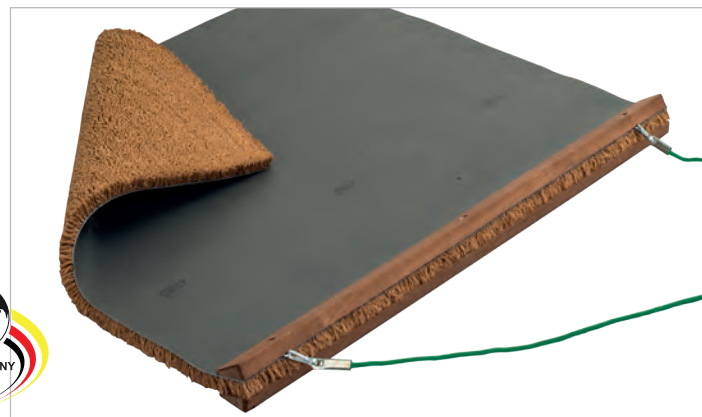

### Special Smoothing Mat for Silica Sand

3 cm long coconut fibers, cast in PVC material. Complete with drag cord.

Size 120 x 90 cm

No. 40885

### Replacement Special Smoothing Mat

Size 120 x 90 cm

No. 40886

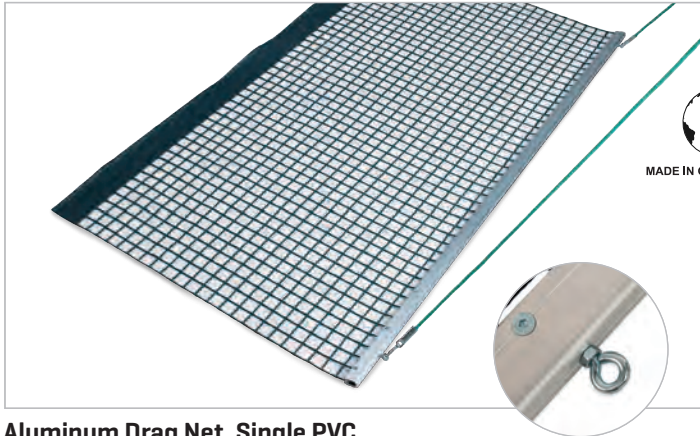

### Aluminum Drag Net, Single PVC

One PVC-coated net 200 x 115 cm, with aluminum rail. Suitable for clay and shale courts.

No. 40980

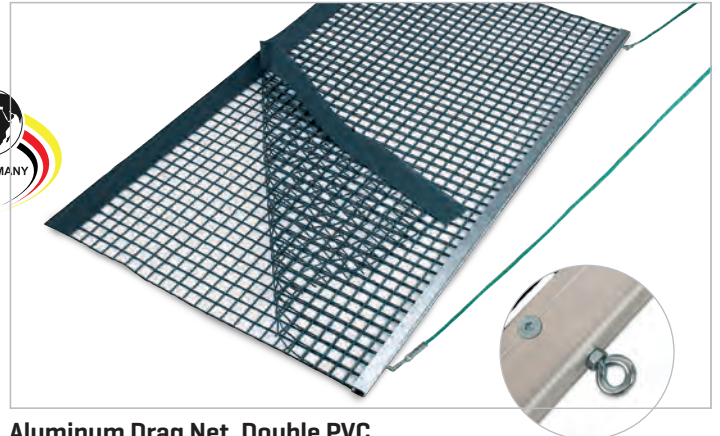

### Aluminum Drag Net, Double PVC

Two PVC-coated nets 200 x 115 cm, with aluminum rail. Suitable for clay and shale courts.

No. 41010

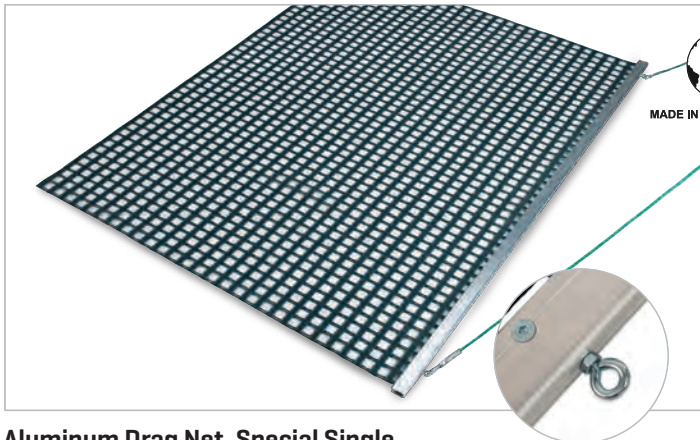

### Aluminum Drag Net, Special Single

One Extra-PVC fabric net with aluminum rail and drag cord. Working width 200 cm, depth 150 cm.

No. 410301

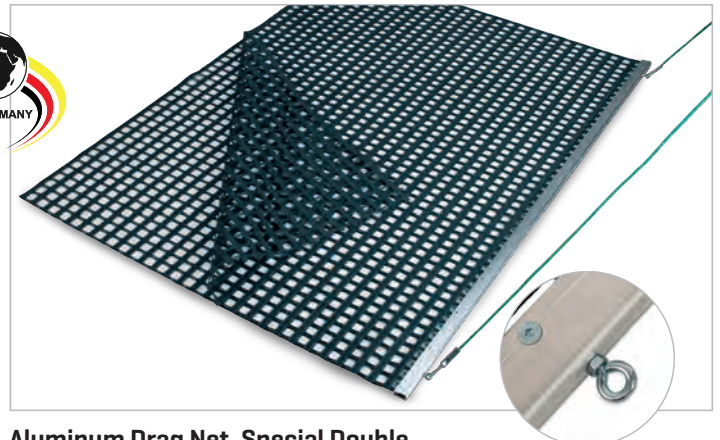

### Aluminum Drag Net, Special Double

Two special-PVC fabric nets with aluminum rail and pull-handle. Working width 200 cm, depth 150 cm.

No. 410302

### Uniplan Exclusiv Court Royal

The latest trawl of a special kind. Double heavy trawl net fabric with 75 cm net depth, with aluminium pull rod and trawl line included. Suitable for all types of clay courts. Developed by customers for customers with the expertise of experienced groundsmen. A Court Royal product in a class of its own. Working width 190 cm, net depth 75 cm

No. 41024

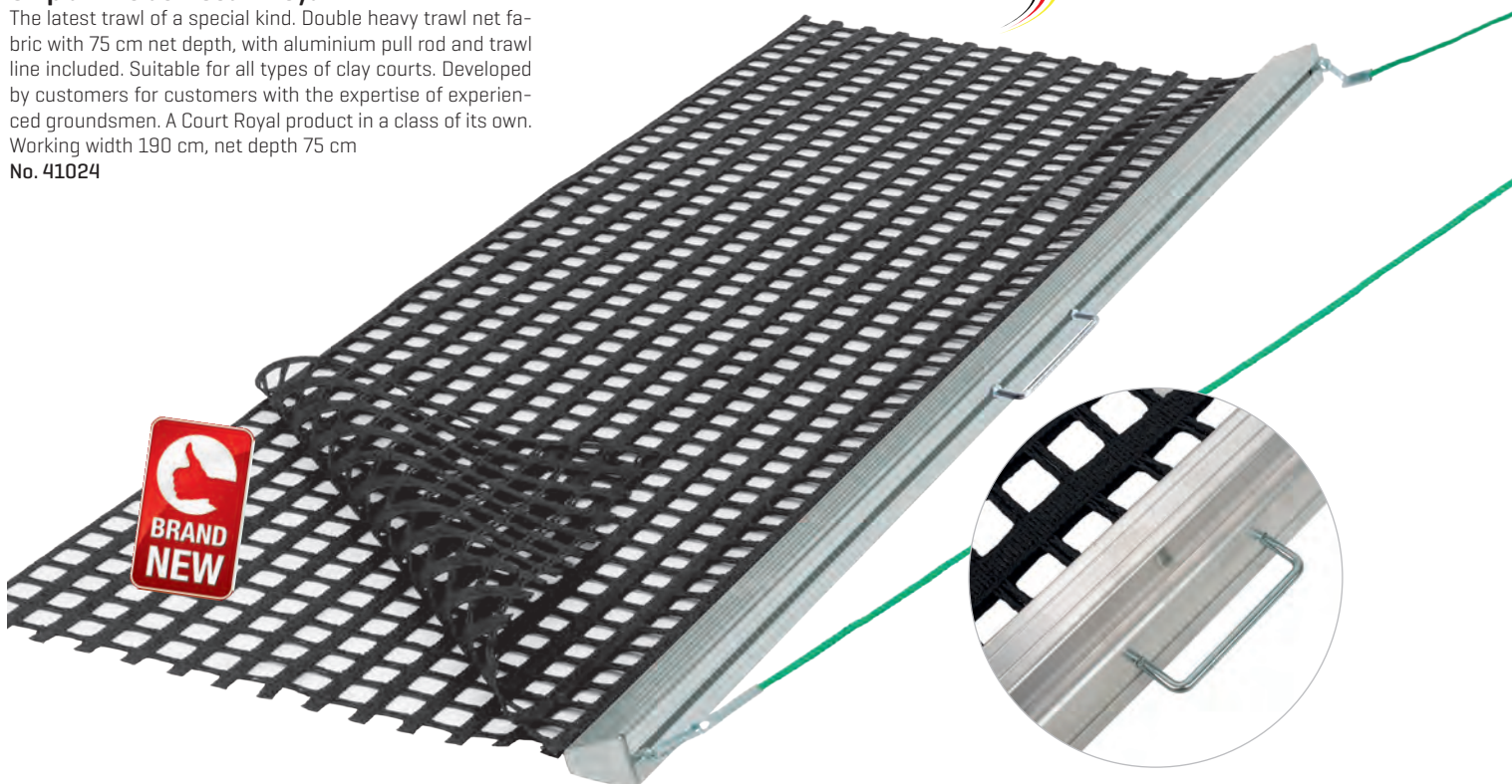



### Wooden Drag Net, Single PVC

One PVC-coated net 200 x 115 cm, with wooden rail. Suitable for clay and shale courts.

No. 41021



### Wooden Drag Net, Double PVC

Two PVC-coated nets 200 x 115 cm, with wooden rail. Suitable for clay and shale courts.

No. 41020

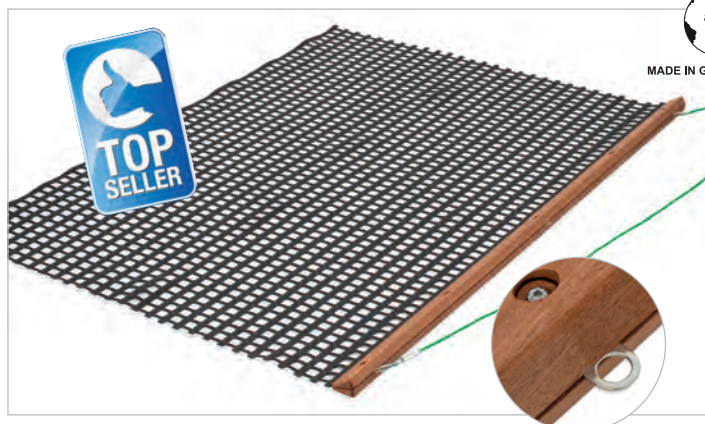

### Wooden Drag Net, Special Single

One special PVC fabric net 200 x 150 cm, with wooden rail. Suitable for clay and shale courts.

No. 41030

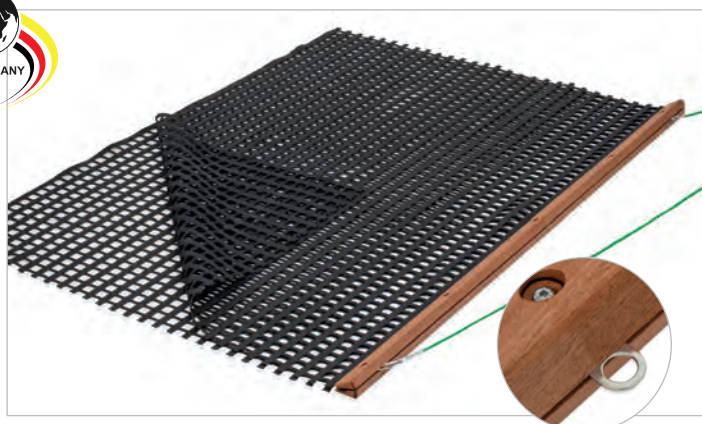

### Wooden Drag Net, Special Double

Two special PVC fabric nets 200 x 150 cm, with wooden rail. Suitable for clay and shale courts.

No. 41041

### Aluminum Rail

Width 200 cm, complete with drag cord.

No. 40990



### Wooden Rail

Triangular wood, pre-drilled with screws. 200 cm, complete with drag cord.

No. 40992



### Pull Handle

Aluminum pull handle compatible with all tennis court brooms, broom-mats and wooden drag nets.

No. 40861

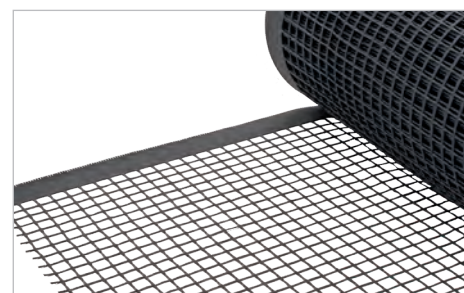

### Drag Net Material PVC

Width 1.15 m. Total length of the roll 130 m. For drag net self-assembly.

No. 41001

No. 410011

per m  
per piece á 2 x 1,15 m

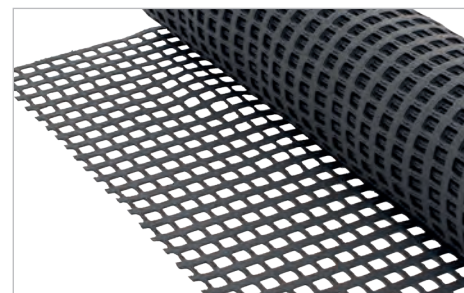

### Drag Net Material Extra

Width 1.50 m. Total length of the roll 130 m [45 sqm], or drag net self-assembly.

No. 41031

No. 410331

sqm  
per piece á 2 x 1,5 m



Our wooden drag rail are made from torsion-free red pine wood patios. More than 150.000 been produced.



### Drag Cord

3.5 m long with spring hooks.

No. 41002

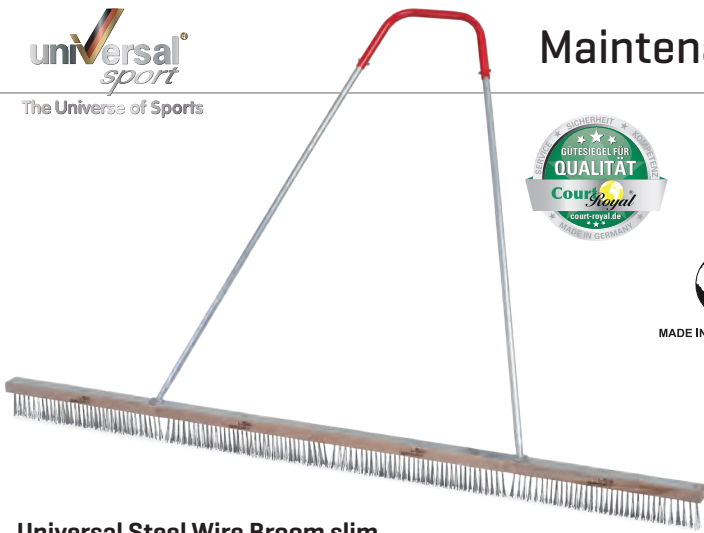

### Universal Steel Wire Broom slim

For scratching the court surface and removing leaves from court. Ideal device for spring, season and autumn. Light design with aluminum rail and drag cord.

200 cm width

No. 40925

**Replacement Broom** 200 cm

No. 40926

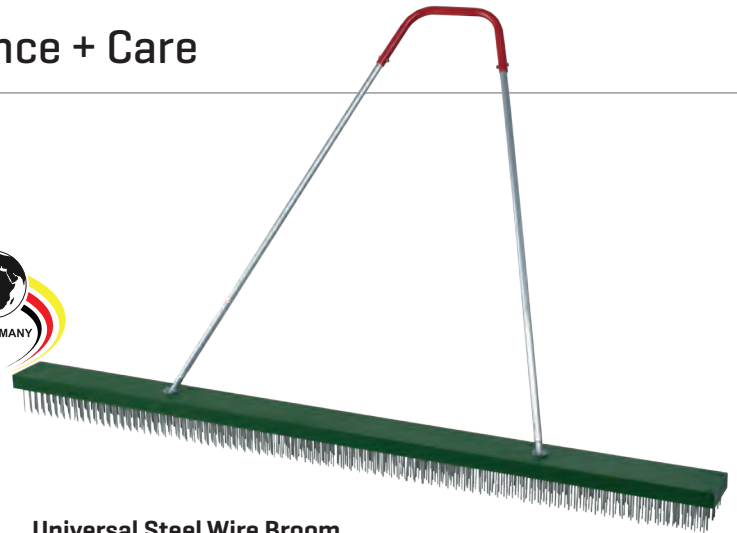

### Universal Steel Wire Broom

Roughening of hard and water-impermeable tennis courts. For removing surfaces overgrown with moss. Ideal equipment for the work in spring. Should not be missing on each tennis court. Heavy model including aluminum pulling handle.

No. 40920

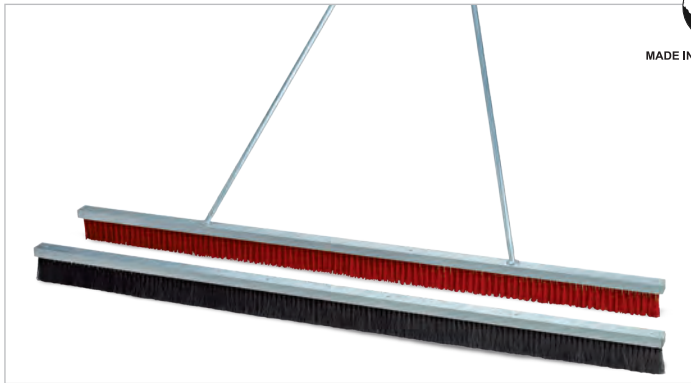

### Tennis Court Broom

With long, narrow bristles. Wide aluminum bracket and frame, 200 cm width.

No. 40943 Plastic

No. 40942 Arenga

### Replacement Brush 200 cm

No. 409430 Plastic

No. 409420 Arenga



### Tennis Court Broom I

With long, narrow bristles. Easy handling due to the adjustable pulling handle.

Aluminium frame, 270 cm width.

No. 40950 Plastic

No. 40940 Piassava

### Replacement Brush 135 cm

No. 40970 Plastic

No. 40960 Piassava

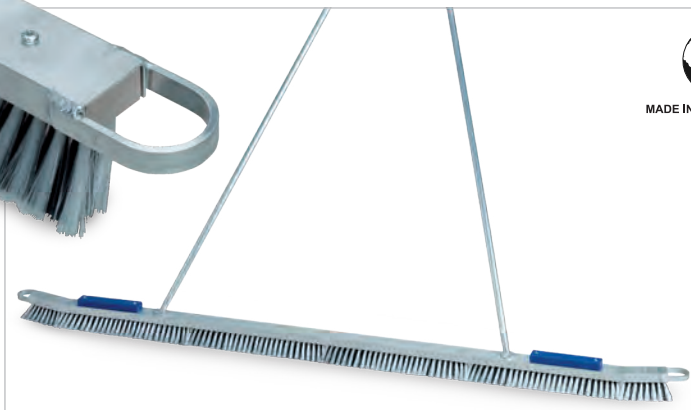

### Granu-Top Broom

This is the perfect broom for cleaning granular surfaces. The bent ends of the broom and the position of the bristles guarantee an even spread of granules. The static supercharge cleans debris abraded from the balls and lint from the surface. Complete with aluminum handle and weights on both ends.

Working width 200 cm.

No. 41076

### Replacement Brush for Granu-Top

No. 410761



### Broom for Granular Surfaces

Broom with Arenga bristles for hall floors with rubber granular. The special position of the bristles guarantees an even sliding of the broom. Complete with a very sturdy aluminum handle in three parts. Working width 200 cm.

No. 41075

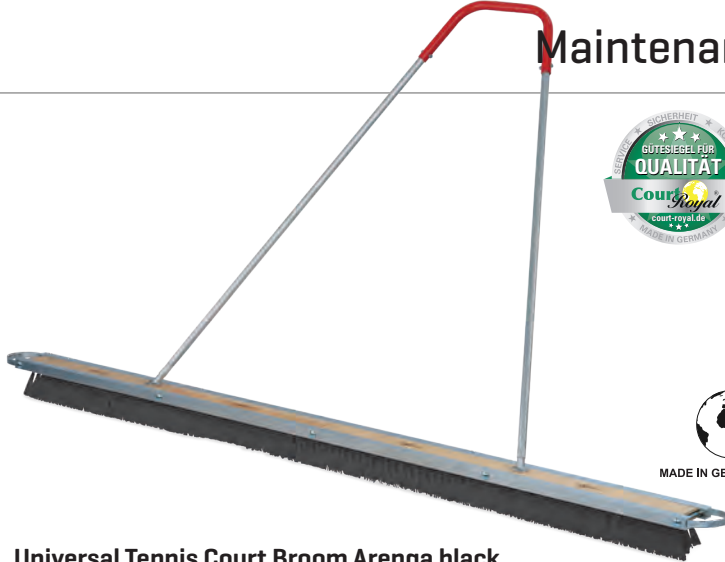

### Universal Tennis Court Broom Arenga black

With four replaceable broom parts in aluminum frame, complete with aluminum pulling handle, 200 cm width.  
No. 40870

### Universal Tennis Court Broom Plastic red

The 200 cm width smoothing broom with 4 replaceable broom parts is the ideal maintenance device for clay courts. The aluminum base frame has net guards on each side. Complete with a two-part, sturdy aluminum pulling handle.  
No. 40860

### Replacement Brush Arenga black

No. 40900 50 cm

### Replacement Brush Plastic red

No. 40890 50 cm

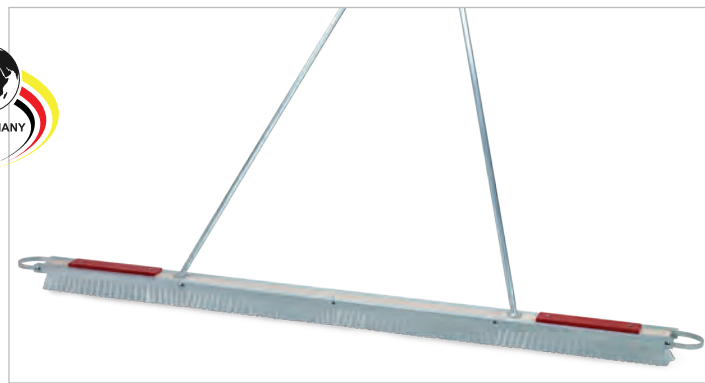
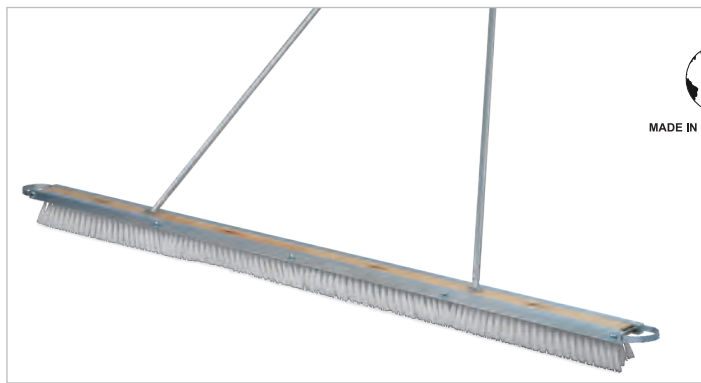

### Universal Tennis Court Broom Plastic white

Smoothing broom with 4 replaceable broom parts is the ideal maintenance device for clay courts. The aluminum base frame has net guards on each side. Complete with a two-part, sturdy aluminum pulling handle, width 200 cm.  
No. 40865

### Tennis Court Broom Special

Four replaceable plastic broom parts in aluminum frame, two additional weights to stop the broom from hopping or jumping, 200 cm width. Complete with aluminum pulling handle.  
No. 40862

### Replacement Brush Plastic white

No. 40864 50 cm

### Replacement Brush Special

No. 40864 50 cm

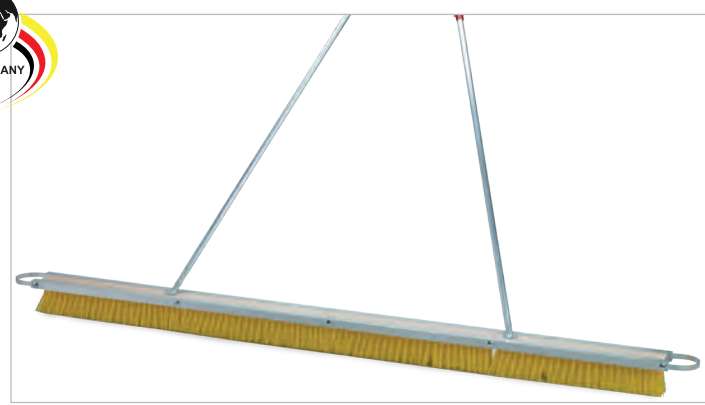

### All-Weather Smoothing Broom

The newly developed 200 cm width smoothing broom with 4 replaceable broom parts is the ideal maintenance device for clay courts. The brush section consists of two rows of plastic bristles and three rows of Arenga bristles. The plastic bristles at the front loosen the material, the Arenga bristles at the rear distribute the loosened material evenly over the court. The aluminum base frame has net guards on each side. Complete with a two-part, sturdy aluminum pulling handle.  
No. 40935

### Tennis Court Broom for Quartz Sand Plastic yellow

The Smoothing Broom with 4 replaceable broom parts is the ideal maintenance device for quartz sand courts. The aluminum base frame has net guards on each side. Complete with a two-part, sturdy aluminum pulling handle, width 200 cm and yellow plastic bristles.  
No. 40881

### Replacement Brush

No. 40936 Plastic / Arenga 50 cm

### Replacement Brush Plastic yellow

No. 40883 50 cm





**Line Brush TOP**

Sturdy plastic-coated aluminium handle with joint. Brush with high-quality bristles.

- No. 41134 Arenga [soft]
- No. 41137 Plastic [hard]

**Replacement Brush TOP**

- No. 41135 Arenga [soft]
- No. 41138 Plastic [hard]



**Line Brush I without handle**

- No. 41100 Plastic
- No. 41110 Arenga

**Wooden Handle**

- Ø 24 mm, length 1,5 m.
- No. 40091

**Aluminum Handle ROYAL**

No. 41128

**Wooden Handle ROYAL**

No. 41129



**Hand Broom ROYAL**

Molded plastic body with low-wear bristles. Exclusive model with joint made of environmentally friendly recycled plastic. The ideal line broom with long durability.

No. 41113 without handle

**Wooden Handle for ROYAL**

No. 411132

**Aluminum Handle for ROYAL**

No. 411131



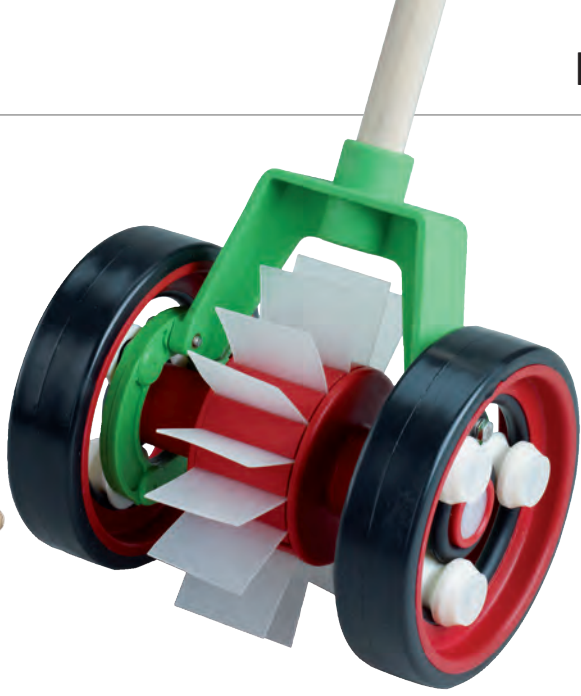

### Line Master

This new line cleaning machine is the best-seller in the USA. The friction-wheel drive, powered by the solid rubber wheels, pins the plastic brush to clean lines quickly and easily. Robust aluminum case with ergonomically shaped handle.  
No. 41087



### Line Lightning Sweeper

Perfected, well-designed line cleaner for all surfaces, especially clay, shale and rubber granule surfaces. All parts replaceable. Without handle.  
No. 41081

### Replacement Sweeper Blades

No. 41084

### Replacement Rolls

No. 41085

### Replacement O-ring set of four

No. 41086

### Bracket

No. 41088

### Replacement Wheels set of two

No. 41089



### Match Liner

This line sweeper is unsurpassed in price and handling. Well thought-out, smooth-running construction made of weather-resistant and abrasion-resistant materials. When the drive wheels roll, the brush is driven in the opposite direction, ideal for all types of tennis lines. Without a handle. Brush width 4 cm and 5 cm

No. 41082 4 cm

No. 41092 5 cm

### Replacement Brush

No. 41083 4 cm

No. 410921 5 cm

Handle 24 mm

No. 40091



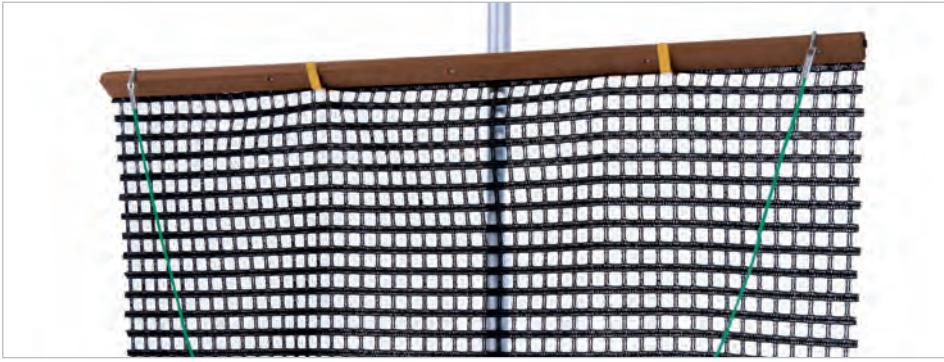

### Drag Net Double Holder

The newly developed double drag net holder for ideal storage of smoothing and drag nets. Made of aluminum tubing with two hooks and a fixing bracket for fence posts with Ø 60 mm. The holder is coated in yellow plastic and therefore easily visible.  
No. 41434



### Rubber Squeegee "Dry Court"

Made of aluminum, 145 cm wide, replaceable rubber blade, 2 durable wheels in front. Easy and convenient for water removal and ball collection. Works especially well around pools, on driveways, golf greens and any flat or hard surfaces. Comes with one blade for replacement.  
No. 41183

### Replacement Rubber Blade

No. 41184



### Tool Holder

Zinc-plated steel, fixing bracket with standard hook. To hang brooms, drag nets and smoothing mats.  
No. 41430 Ø 45 mm  
No. 41440 Ø 60 mm

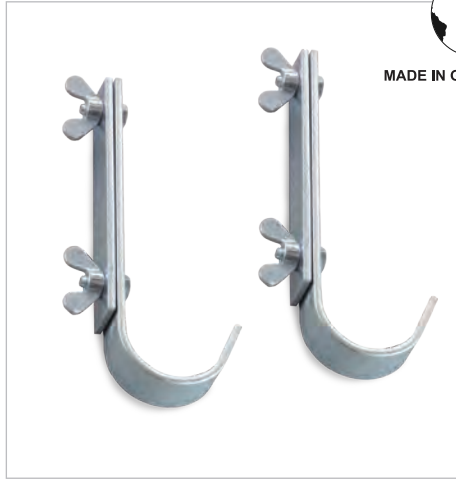

### Drag Net Holder

Made of galvanized flat iron, 3 mm thick, includes fixing materials for trouble-free assembly on fence post.  
No. 41443



### Handle Holder

For line brushes and all other equipment with a broom handle diameter of 23-28 mm. The rubber holder holds the handle securely. The holder can be easily attached to a fence post with Ø 60 mm, by using clamps.  
No. 414321



### Tool Holder EXTRA

Fixing clamp with rubber lining. Does not damage fence posts. All steel parts zinc-coated. For brooms, drag nets and smoothing mats. For fence post with 60 mm Ø.  
No. 41435

Alle Preise verstehen sich inkl. gesetzlicher MwSt.



### Tool Holder

Fixing clamp with 1 hook. For brooms, drag nets and smoothing mats. Made of zinc-coated steel, for fence post with 60 mm Ø.  
No. 41431



### Hand Brush Holder

Fixing bracket with 2 hooks for hanging hand brushes. Made of steel, for fence post with 60 mm Ø.  
No. 41433



## Tennis Court Drying Sponge

Special viscose sponge. Size: 50 x 30 x 8 cm, for draining individual water points. The sponge is placed on the water point, it soaks up water on its own and can then be easily washed out of the area.  
No. 41155



## Tennis Court Drying Set

Bucket with galvanized grid plate and sponge with aluminum handle. To soak up small puddles on the court.

No. 41182



## Water Roller

Foam rubber roller with handle. To clear puddles from hard courts, 90 cm wide. All metal parts galvanized.

No. 41180

## Spare Roller for Water Roller

No. 41181



## Scissor sponge roller

For removing puddles of water with replaceable suction cylinder made of special foam and aluminium scissor handle.

- Length incl. roller body approx. 1440 mm
- Total width at bottom approx. 520 mm
- Width of roller body 500 mm
- Top handle width approx. 520 mm
- Weight 4 kg
- Suction capacity of sponge approx. 4.2 litres

No. 411855

## Replacement sponge roller

No. 411856



## Universal Absorbing Roller Special

Absorbing drum with foam rubber covering, hot-galvanized frame and drum body. Thanks to the huge absorbent capacity of this roller it is possible to make a court playable again in a very short period of time. Working width 80 cm.

No. 41141

## Replacement Absorbing Drum

No. 41150

## Replacement Sponge with adhesive

No. 41151

## Sponge roller Special

Innovative maintenance tool that removes puddles of water from the tennis court in the shortest possible time. Thanks to the specially designed surface structure, the sponge roller has an enormous suction volume. In addition, sand or other materials do not stick. With the handles provided for this purpose, the sponge can be squeezed out in a vertical position in a matter of seconds. Suitable for brick dust, quartz sand or hard court surfaces.

- Sponge width approx. 500 mm
- Sponge diameter approx. 230 mm
- Weight 4.9 kg

No. 41185

Alle Preise verstehen sich inkl. gesetzlicher MwSt.





### Full-circle Sprinkler

Large surface sprinkler with a circle diameter of 32 m, thus sprinkling a total area of 800 sqm. Connection 3/4". Without tripod.

No. 41322



### Part-Circle and Full-Circle Sprinkler

Large surface sprinkler with a circle diameter of 32 m, thus sprinkling a total area of 800 sqm. Working area can be adjusted from 20° to 340°, or full-circle. Connection 3/4". Without tripod.

No. 41321

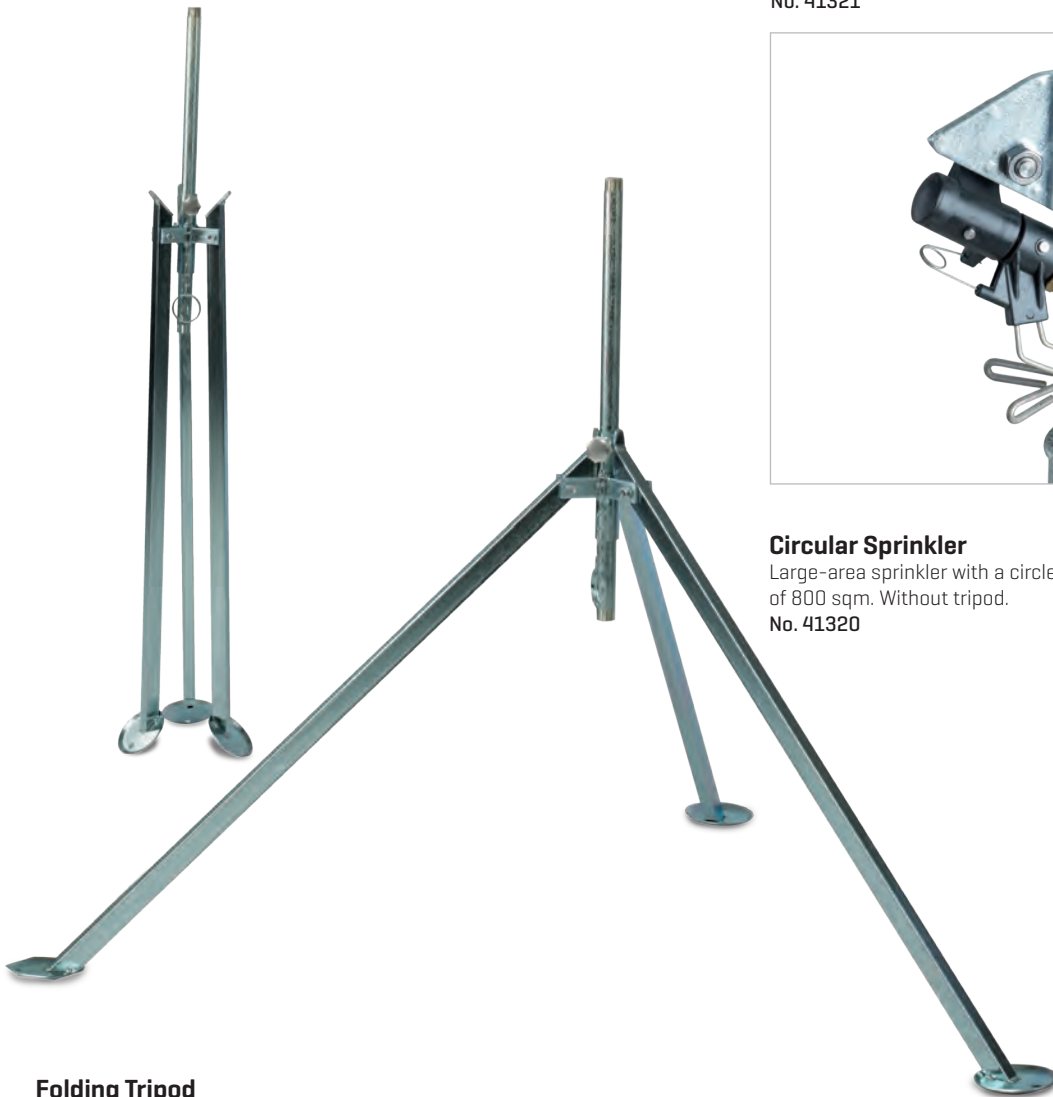

### Folding Tripod

Specially developed for the tennis court. Large foot disks prevent damage to the court surface. Folding mechanism makes it easy to handle and to store in small places. Suitable for all types of sprinklers in our catalog.

No. 41323



### Circular Sprinkler

Large-area sprinkler with a circle diameter of 32 m, thus sprinkling a total area of 800 sqm. Without tripod.

No. 41320



### Perrot - Turbo Quadrilateral Sprinkler

Triton SW

Single-jet oscillating lever sprinkler with hot-dip galvanized steel housing, galvanized steel-plastic coated perimeter plate and impact- and break-resistant plastic housing cover. 22° stream rise and stream disrupter to vary the throw side and water distribution. Polyamide guide housing with brass stabilization.

No. 41331



### Spray Nozzle

Large nozzle sprinkles evenly over large areas. Complete with Geka connection and tube.

No. 41340



### Spray Nozzle with Shut-Off Valve

Large nozzle sprinkles evenly over large areas. Complete with Geka connection and tube. With shut-off valve.

No. 41350



### Pistol Spray Nozzle

Large nozzle sprinkles evenly over large areas. With a pistol grip. Optimum adjustment of sprinkling with shut-off device.

No. 41360



### Adjustable Nozzle

Made of light alloy metal with hard PVC steel tube. Metal ball valve lever and spray adjuster. Jet length approx. 15 m. Complete with Geka connection.

No. 41361



5-ply PVC quality hose, UV and ozone resistant, free from algae formation, phthalate-free, high-strength polyester yarn with patented SMT Steady Mesh Technology that actively prevents the hose from twisting.

Properties: extremely easy to handle, excellent flexibility even at low temperatures, high resistance to kinking and crushing. [Temperature -15° to +65°] Applications: for irrigation of tennis courts and sports facilities.

No. 41372 25 m 3/4"

No. 41373 50 m 3/4"

No. 41375 25 m 1"

No. 41376 50 m 1"



### Geka adapters, brass

No. 41391 3/4"

No. 41401 1"

### Gaskets for Geka

set of 10 pieces

No. 41342

### Connectors, brass with Geka

No. 41402 3/4"

No. 41404 1"

### Gaskets for internal thread

set of 10 pieces

No. 41405 3/4"

No. 41406 1"

### Hose clip set of 10 pieces

For water hose up to 2"

No. 41403

### Gaskets for spray nozzle

set of 5 pieces

No. 41341



## SANDY – Brick Sand Distributor

The SANDY brick sand distributor has been thoroughly revised and now makes new sanding during spring repairs even easier and more effective. 2 helpers for the material supply and a good half hour are enough to apply a carpet of brick dust such as sand evenly and in one operation. Sandy can be moved easily by hand and holds approx. 120 kg of fresh brick dust. With dimensions of approx. 1000 x 500 x 600 mm, it is very easy to handle and has an ideal weight of approx. 50 kg. Working width 990 mm. The functional sand spreader was developed by experts and has proven itself in practice on a number of sites. The fresh brick dust carpet is no longer driven over after application. Even on uneven surfaces, you can achieve a completely smooth surface that then only needs to be treated with the trawl.  
No. 40142



## Milling machine for tennis court surfaces USP 10

It really is bordering on witchcraft when you realise the time and precision with which spring overhauls are now carried out with this special milling machine. Previously, groundsman and members had to laboriously remove the used brick dust by hand. Often too little material was removed. Tennis court surfaces became thicker and more impermeable. The USP 10 tennis court tiller overcomes these problems effortlessly! The exact height is adjusted by hand using 2 wing screws. This can be done independently on both sides. This device allows the tilling depth to be determined with millimetre precision. The milled material is ejected in strips and can be shovelled into wheelbarrows with little effort. The power of the 5.5 hp Honda engine ensures that work with the USP 10 tennis court tiller is absolutely even, so that the courts remain level or become level again. Thanks to a comprehensive service network, maintenance and repair of the quietly running engine is guaranteed everywhere. The USP 10 tennis court tiller rolls on 2 independently mounted roller bodies at the front. This distributes the pressure evenly so that it hardly sinks in, even on thawed courts in spring. The rear, treadless solid rubber wheels and the low weight make the machine extremely manoeuvrable and mobile. The USP 10 tennis court tiller fits through any access door and can easily be operated by one person.

### Technical data:

- Length approx. 800 mm - Width approx. 850 mm - Height approx. 1000 mm
- Milling width approx. 655 mm - Weight approx. 75 kg
- Honda engine, 4-stroke, 4.0 kW/5.5 hp

No. 40140



## Manual Roller I Spezial

Suitable for tennis courts and sports fields. Working width 90 cm. Empty weight 60 kg, with water filling 180 kg, one-piece roller body with rounded edges and counterweights.  
No. 40170

## Manual Roller I

As above, but without counterweights.  
No. 40171

## Manual Roller II Special [s. Abbildung nebenstehend]

As above, but much more manoeuvrable due to the split roller body.  
No. 40180

## Manual Roller II

As above, but without counterweights.  
No. 40181

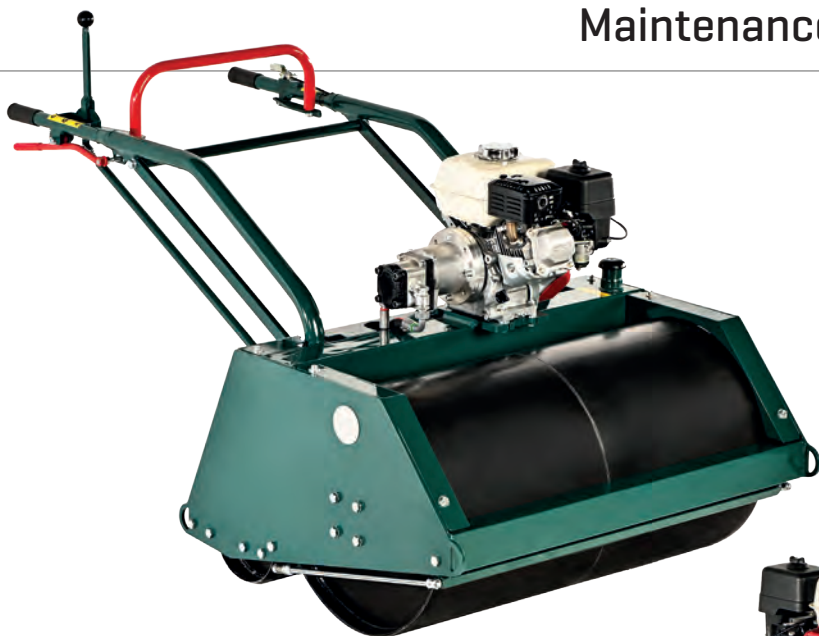

## Motor Roller USP two-piece, new generation

The USP tennis court rollers of proven design and quality with new panning, improved once again. With two-part roller body with equalising differential for better turning of the roller. The mechanically turned roller body characterises this USP motor roller. The 900 mm wide trailing roller prevents the roller from sinking into the tennis surface. Better noise insulation and the biodegradable hydraulic oil are unrivalled are unrivalled.



### Technical data:

Engine: Honda GX 160, four-stroke engine  
4.0 kW = 5.5 hp at 3600 rpm.  
Electronic, contactless ignition,  
oil warning control system, smooth  
running,  
Intake noise insulation

Easy start due to  
automatic decompression system

Fuel: unleaded regular petrol  
Drive: hydraulic  
Roller body: two-piece, 900 mm wide, with differential  
for high manoeuvrability, diameter Ø 500 mm  
Speed: stepless up to approx. 5 km/h; forwards and back  
wards  
Working width: 900 mm  
Weight: empty approx. 350 kg, filled approx. 480 kg  
Dimensions: length: 1800 mm, width: 985 mm, height 1100 mm  
With biodegradable hydraulic oil!

No. 40136



## Motor Roller Zagro FUTURA - Self-Driving

Mount motor roller with a swivelling seat, rubber-coated, broad drive front wheel, split roller body with compensation differential for high manoeuvrability. Simple and easy rolling on the tennis courts.

### Technical data:

Motor: Honda GX 160, 4-stroke engine 4,0 kW at 3600 U/min.  
Fuel: unleaded gasoline  
Drive: hydraulic drive  
Roller: single-piece or split; width 900 mm, Ø 508 mm  
Speed: infinitely adjustable to approx. 6 km/h,  
forward / reverse

Working width: 900 mm  
Weight: empty ca. 380 kg, full ca. 510 kg  
Dimensions: length: 1800 mm, width 990 mm, height: 1050 mm  
No. 40152



## Nets + Accessories





# Court Royal<sup>®</sup>

## Advantage for COURT ROYAL tennis nets

With our COURT ROYAL brand, we have been one of the world's leading manufacturers of high-quality tennis nets for all performance classes for over 40 years, from club sport to international ATP professional tournaments.

Our nets are exclusively hand-knotted and, thanks to their elasticity, offer above-average durability on the one hand and optimum shock-absorbing rebound behaviour on the other.

All tennis nets from our large range are supplied with a steel cable, are labelled with the „tested safety“ seal and meet the strict requirements of DIN EN 1510.



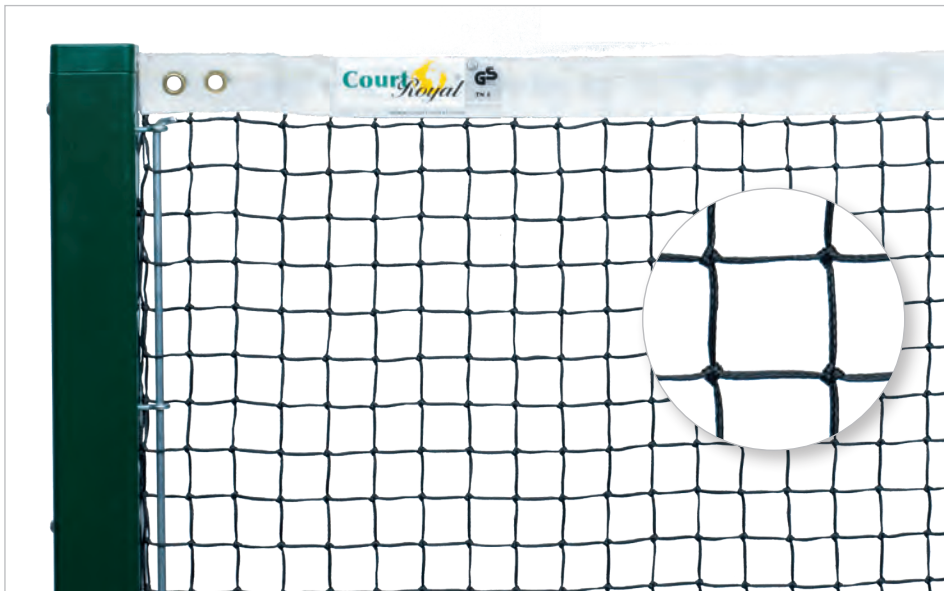

### Tennis Net Court Royal TN 8

Made of 3.2 mm braided polyethylene, hand-knotted, black, stable polyester net enclosure stitched four times, complete with steel wire. DIN EN 1510. With European Seal of Approval. No. 40549 black



### Tennis Net Court Royal TN 15 black

Made of 3.2 mm braided polyethylene, black, hand-knotted, the upper 6 rows double-knotted, stable polyester net enclosure stitched 4 times. A super tennis net, long-lasting, good quality. Complete with steel wire. DIN EN 1510. With European Seal of Approval. No. 40550 black



### Tennis Net Court Royal TN 20 black

Made of 3.4 mm braided polyethylene, black, hand-knotted, the upper 6 rows double-knotted, stable polyester net enclosure stitched four times. 1000 times proven, classic tennis net. Used in the tennis league, ATP-tournaments, Davis-Cup, as well as in the Olympics. A top-class product. Complete with steel wire. 2 years factory warranty on the netting. DIN EN 1510. With European Seal of Approval. No. 40560 black





## Tennis Net Court Royal TN 9

Made of 3.4 mm braided polyethylene, hand-knotted, black, stable polyester net enclosure stitched 6 times, complete with plastic-coated steel cable. Sides and bottom with heavy, black plastic edging as well as two 10 mm strong fiberglass rods for lateral fixing. Long-lasting and very durable. 3 years factory warranty on the netting. DIN EN 1510. With European Seal of Approval.

No. 40545 black



## Tennis Net Court Royal TN 15 green

Made of 3.2 mm braided polyethylene, green, hand-knotted, the upper 6 rows double-knotted, stable polyester net enclosure stitched 4 times. A super tennis net, long-lasting, good quality. Complete with steel wire. DIN EN 1510. With European Seal of Approval.

No. 40552 green



## Tennis Net Court Royal TN 20 green

Made of 3.4 mm braided polyethylene, green, hand-knotted, the upper 6 rows double-knotted, stable polyester net enclosure stitched four times. 1000 times proven, classic tennis net. Used in the tennis league, ATP-tournaments, Davis-Cup, as well as in the Olympics. A top-class product. Complete with steel wire. 2 years factory warranty on the netting. DIN EN 1510. With European Seal of Approval.

No. 40570 green

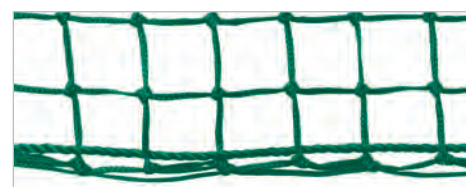



### Tennis Net Court Royal TN 90 black

Made of 3.8 mm braided polyethylene, hand-knotted, the upper 6 rows double-knotted, stable polyester net enclosure stitched four times, complete with plastic-coated steel cable. Sides and bottom with heavy, black plastic edging, as well as 10 mm strong fiberglass rods for lateral fixing. Long-lasting and very durable. A tennis net in a special class. 3 years factory warranty on the netting. DIN EN 1510. With European Seal of Approval.

No. 40610 black



### Tennis Net Court Royal TN 30

Made of 3.8 mm braided polyethylene, hand-knotted, the upper 7 rows double-knotted, stable polyester net enclosure stitched 6 times, complete with plastic-coated steel cable. Sides and bottom with heavy, black plastic edging as well as two 10 mm strong fiberglass rods for lateral fixing. Long-lasting and very durable. 3 years factory warranty on the netting. DIN EN 1510. With European Seal of Approval.

No. 40548 black

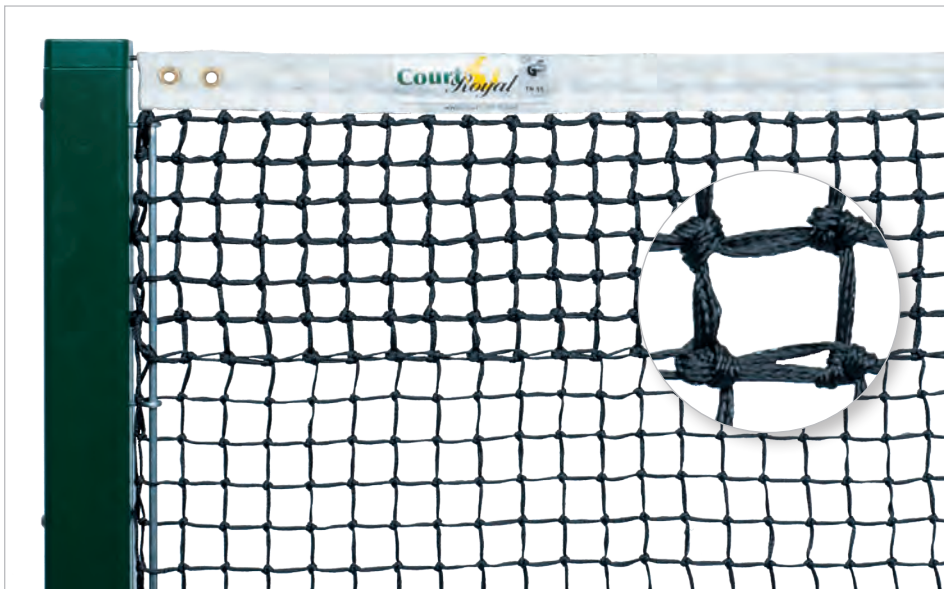

### Tennis Net Court Royal TN 50 Tournament

Made of 3.5 mm braided polyethylene. Hand-knotted, the upper 7 rows double-knotted, very stable polyester net enclosure stitched four times. Complete with plastic-coated steel cable. 2 years warranty on the netting. Mesh size 4 cm, prevents balls becoming stuck in the net. DIN EN 1510. With European Seal of Approval.

No. 40565 black





## Tennis Net Court Royal TN 90 green

Made of 3.8 mm braided polyethylene, hand-knotted, the upper 6 rows double-knotted, stable polyester net enclosure stitched four times, complete with plastic-coated steel cable. Sides and bottom with heavy, black plastic edging, as well as 10 mm strong fiberglass rods for lateral fixing. Long-lasting and very durable. A tennis net in a special class. 3 years factory warranty on the netting. DIN EN 1510. With European Seal of Approval.

No. 40611 green

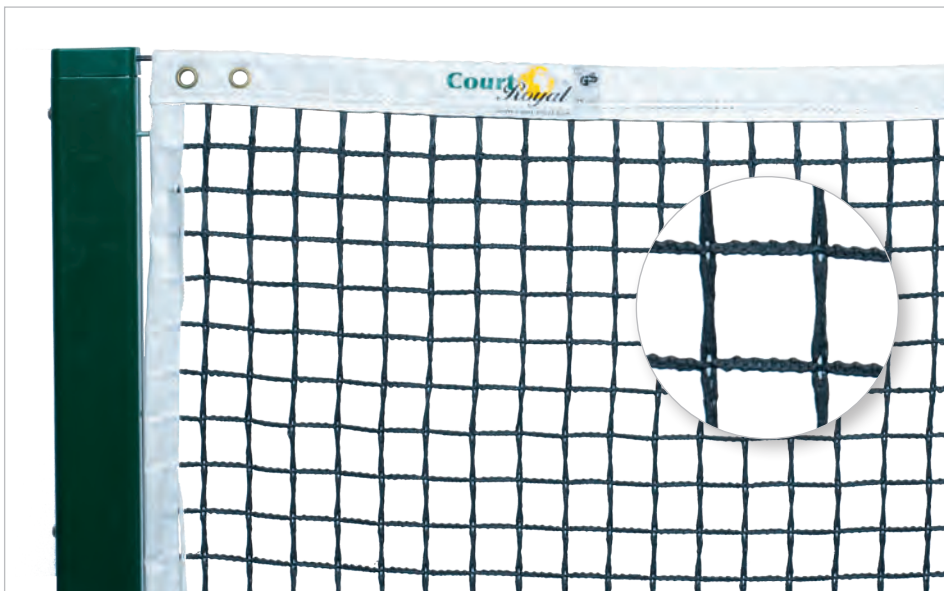

## Deluxe Tennis Net Court Royal TN 200

Made of approx. 5 mm polyester fabric with a black plastic cover. Stable edging with steel cable. Very long life. An almost indestructible tennis net. 5 years factory guarantee on the mesh fabric. GS-tested according to DIN EN 1510.

No. 40580 black



## Tennis Net Court Royal TN 55 Tournament Singles

Made of 3.5 mm braided polyethylene. Hand-knotted, the upper 7 rows double-knotted, very stable polyester net enclosure stitched four times. Complete with plasticcoated steel cable. 2 years warranty on the netting. Mesh size 4 cm, prevents balls becoming stuck in the net. DIN EN 1510. With European Seal of Approval.

No. 40566 black





### Tennis Net Post Court Royal TP 83

Round post, Ø 83 mm. Special reinforced aluminum profile with groove for fastening the net holding rod. Internal trapeze tensioning mechanism with an aluminium key for easy net tensioning. Clip-on cap made of cast aluminum including safety chain. Overall length of posts: 142 cm. Weight: 10.5 kg. Aluminium ground sleeves, depth of insertion 35 cm, complete with cast aluminum cover. Meets the European DIN EN 1510 safety standard.

**No. 404001** aluminum anodized  
**Delivery without ground sleeves**

**Ground sleeves with cover**  
round sleeves made of aluminum, insertion depth 35 cm, complete with cast aluminum cover. GS tested according to DIN EN 1510.  
**No. 404011**

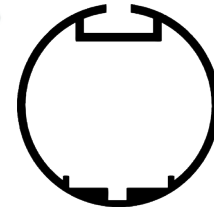

**No. 404101** green powder-coated  
**Delivery without ground sleeves**



**No. 404111** white powder-coated  
**Delivery without ground sleeves**



**No. 404471** black powder-coated  
**Delivery without ground sleeves**



## Tennis Net Post Court Royal TP 80

Square post, 80 x 80 mm. Special reinforced aluminum profile with groove for fastening the net holding rod. Internal trapeze tensioning mechanism with aluminum key for easy net tensioning. Clip-on cap made of cast aluminum including safety chain. Overall length of posts: 142 cm.

Weight: 10.5 kg. Aluminum ground sleeves, depth of insertion 35 cm, complete with cast aluminum cover. Meets the European DIN EN 1510 safety standard.

**No. 404301** aluminum anodized  
**Delivery without ground sleeves**

### Ground sleeves with cover

Ground sleeves made of aluminum, insertion depth 35 cm, complete with cast aluminum cover. GS tested according to DIN EN 1510.

**No. 404311**

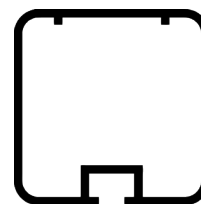

**No. 404401** green powder-coated  
**Delivery without ground sleeves**



**No. 404451** white powder-coated  
**Delivery without ground sleeves**



**No. 404461** black powder-coated  
**Delivery without ground sleeves**

**No. 404481** blue powder-coated  
**Delivery without ground sleeves**





### Tennis Net Post Alu TP 73

Round post  $\varnothing$  73 mm made of green plastic-coated aluminum. Special profile with three compartments, very sturdy with screw-on gear wheel mechanism of aluminum. Net holding rod and all screws and hooks are made of VA steel. Delivery without ground sleeves.

No. 40422



### Tennis Net Post Steel TP 76

Round post  $\varnothing$  76 mm made of green plastic-coated steel pipe with screw-on aluminum gear wheel mechanism with brass rope castors. Removable crank, net-holding straps and net hooks fully welded. Delivery without ground sleeves.

No. 40427



### Ground Sleeves 73

Ground sleeves for 73  $\varnothing$  mm post

No. 404281

### Ground Sleeves 76

Ground sleeves for 76  $\varnothing$  mm post.

No. 40428



### Tennis Net Post USA, Steel 76

76 mm  $\varnothing$  galvanized steel, green powder-coated. With brass gear mechanism, stringing block and a removable crank. Ground sleeves not included. Meets the European DIN EN 1510 safety standard.

No. 40425



### Tennis Net Post USA, Steel 80

80 x 80 mm galvanized steel, green powder-coated. With brass gear mechanism, stringing block and a removable crank. Ground sleeves not included. Meets the European DIN EN 1510 safety standard.

No. 40424



### Ground Sleeves 76

Ground sleeves for 76  $\varnothing$  mm post.

No. 40428

### Ground Sleeves 80 x 80

Ground sleeves for 80 x 80 mm post.

No. 404311





## Spare parts for tennis net posts

**1** Ground sleeve 80 x 80 mm  
No. 40431

**2** Ground sleeve 83 mm Ø  
No. 40401

**3** Cover for Ground sleeve 80 x 80  
No. 40450

**4** Cover for Ground sleeve 83 Ø  
No. 40420

**5** Tensioning mechanism  
No. 40405

**6** Key for tensioning mechanism  
No. 40404

**7** Net holding rod  
No. 40402

**8** Set of screws, eight eye bolts, eight groove sliding blocks and two net hooks  
No. 40403

**9** Cap for blind post 80 x 80  
No. 40416

**10** Cap for mechanism post 80 x 80 mm  
No. 40415

**11** Cap for blind post 83 mm Ø  
No. 40407

**12** Cap for mechanism post 83 mm Ø  
No. 40406

**13** Net repair cord 20 m, 3 mm  
No. 40653 Poly black

**14** Net repair cord 20 m, 3 mm  
No. 40654 Poly green

**Ground sleeve 76 mm Ø**  
No. 40428  
(without illustration)

**Split pin for Tennis net post**  
No. 404041 (without illustration)

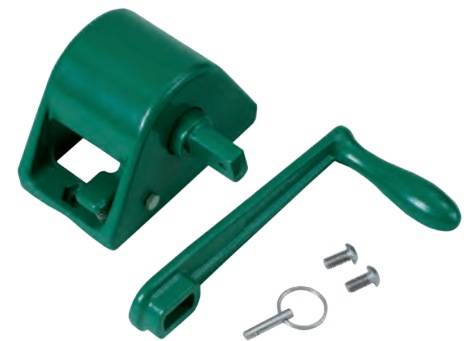

## Crank drive for tennis net posts

This gearwheel winding mechanism can be attached to any post with 2 M8 screws. Pre-drill the holes and cut the M8 thread. You can then use this mechanism to tension the net again.

No. 40429 green  
No. 404291 black



**Center Strap I**

Made of cotton fabric, with brass eyes.  
No. 40700



**Center Strap II**

Made of PVC, with adjustable loops and spring hooks.  
No. 40710



**Center Strap III**

With plastic snap lock, spring hook and Velcro strip.  
No. 40720



**Center Strap IV**

With Velcro closure.  
No. 40711



**Universal Center Strap**

Made of high-strength nylon with stainless steel buckles and special hooks.  
No. 40690



**Replacement Wire with loops**

13.80 m long.  
No. 40660



**Replacement Tennis Net Headband**

Fast to replace, complete with looping string.  
No. 40670



**Center Strap II T**

Made of nylon with adjustment loops, without snap hooks.  
No. 407101



**Court Royal Center Strap**

Made of high-strength nylon with stainless steel buckles and special hooks.

No. 40680





**1 Tennis Net Weight**

Made of steel pipe with suspension eye for strap.  
No. 40721

**2 Ground Anchor I**

Made of stainless steel.  
No. 40740

**3 Ground Anchor Submerged Tube**

Made of aluminum for indoor and all-weather courts. No. 40760

**4 Tensioning Screw**

Made of galvanized iron, with counter nut.  
No. 40730

**5 Ground Anchor Special**

Steel wire with 3 mm eye loop for attachment.  
Anchors when secured in the ground.  
No. 40751

**6 Ground Anchor II**

Galvanized to hammer in, easy to use.  
No. 40750

**Ground Anchor III**

7 U-shaped, galvanized.  
No. 40755



**Single Net Rods Special**

For tennis net system Court Royal.  
Aluminum, frame holder with rubber coating on the underside for a secure stand.

No. 404902 white  
No. 404905 black



**Single Net Rods**

To use for single tournament games, made of aluminum.

No. 40650 unpainted  
No. 40649 white  
No. 40648 green  
No. 40655 black



Used in an aircraft hangar at the official ATP Tennis Tournament in Berlin, in July 2020.



### Tennis Net System Court Royal II Tournament

This newly developed tennis net system is a unique top-class product; it differs from conventional systems through simple modification from double court measurements to single court measurements. Will be delivered in 5 parts. For single court usage the middle part has to be removed and a single net has to be mounted. Delivery is without net, single net rods and center strap. Here we recommend tennis net Court Royal TN 50 No. 40565 (page 28) for doubles and tennis net Court Royal TN 55 No. 40566 (page 29) for single as well as Center Strap II No. 40710 (page 34), weight: 165 kg.

- No. 40485 white
- No. 404851 black



Tennis Net System Court Royal modified for single matches



### Single net support special

Especially for Court Royal tennis net system.  
Aluminium, frame bracket with rubber coating on the underside for a secure stand.  
No. 404905 black



### Additional Weights for ATP, WTA and Davis-Cup

No. 404901 [1 set has 4 weights à 10 kg]

### Centerstrap II T

Made of nylon with adjustment loops, without snap hooks.  
No. 407101



### The Court Royal special adapter makes all posts fit!

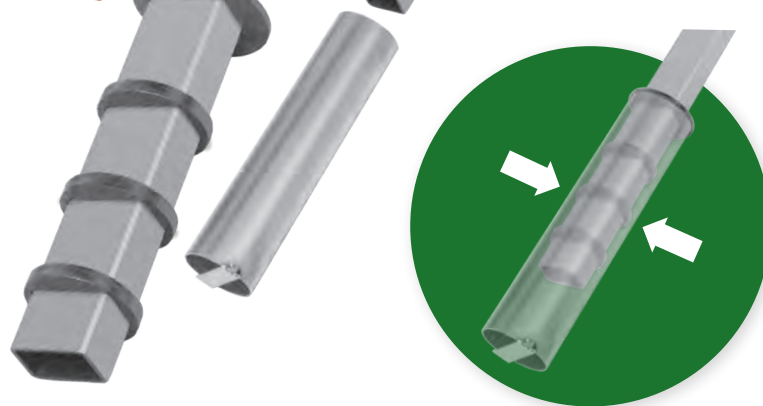

### Special adapter for tennis net posts

Made of hot-dip galvanised steel. You have installed a ground socket profile in the ground, which does not fit a standard post? Then the adapter is the ideal solution. Please specify the diameter of the ground sockets and insertion depth. You can choose any post from our range, round or square - aluminium or powder-coated in colour. aluminium or coloured powder-coated. Suitable for the articles: 404001 / 404101 / 404111 / 404471 / 404301 / 404401 / 404451 / 404461 [page 36 and 37]  
No. 404801

### Tennis net post Court Royal for folding down

This post is used when there is no depth for ground sockets. It is fastened with a 10 mm steel plug and a screw. The 80 x 80 mm aluminium post is held in place by a forward support on the hot-dip galvanised base bracket. The design corresponds to our Royal TP 80 tennis post.  
No. 40470





# Tennis court accessories

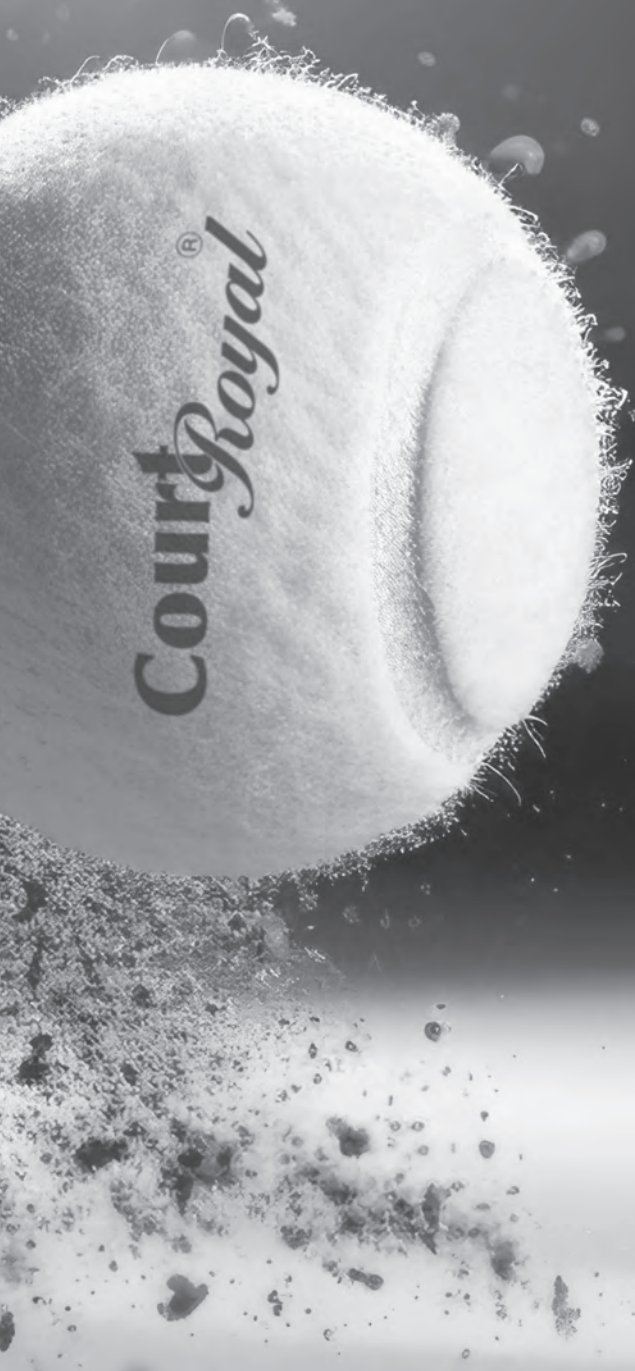

# Tennis Court Accessories

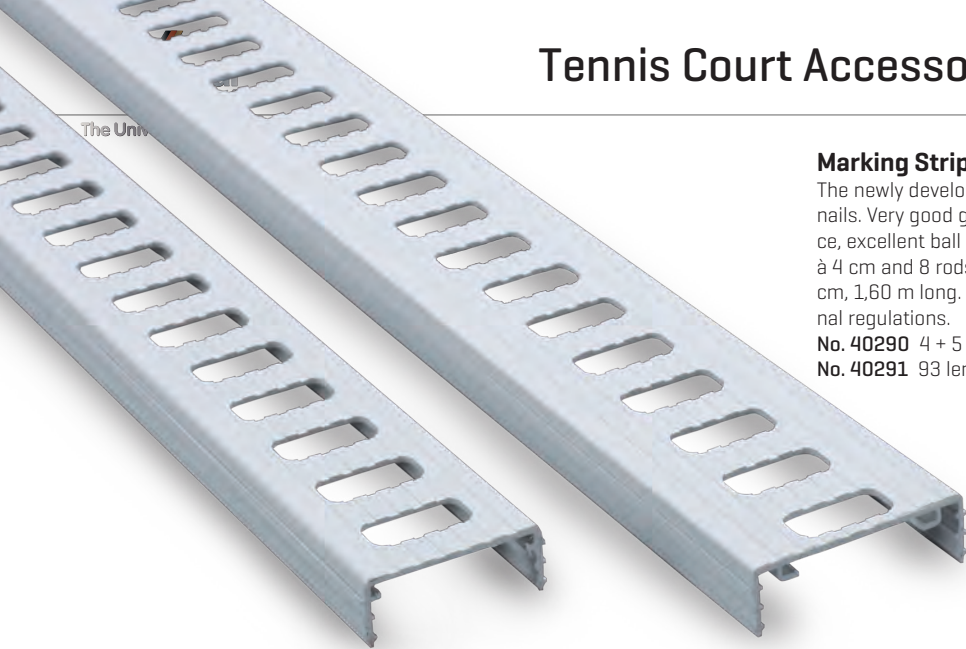

## Marking Strips with Perforations, Universal

The newly developed line with recess is ideal for simple self-installation without nails. Very good grip due to reinforce and extended barbed legs. Non-slip surface, excellent ball bounce behavior. A set of 4 cm and 5 cm consists of 85 rods à 4 cm and 8 rods à 5 cm, each 1,60 m long. A 5 cm set consists of 93 rods of 5 cm, 1,60 m long. Each set contains 100 T-connectors. Complying with international regulations.

No. 40290 4 + 5 cm

No. 40291 93 lengths 5 cm

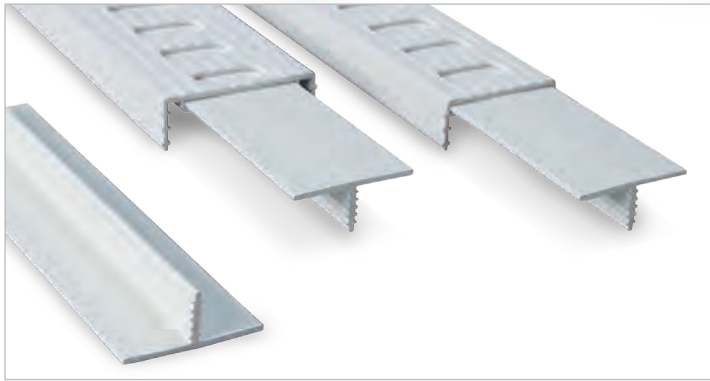

## Replacement Marking Strips with Perforations

Complete with connectors. Set of 10 lengths, each 1.60 m

No. 40292 4 cm

No. 40293 5 cm

## T-connectors

100 per set

No. 40301



## Marking Line I

Installation requires only a few nails (nails not included). Set consists of 3 rolls, each roll 50 m.

No. 40200 4 cm

Only available in complete sets.



## Fastening Nails

Rounded, flat-head, hot-dip galvanized.

Specially made for tennis lines.

5 kg required for each court.

No. 40310



## Treated Wooden Pegs

For securing the corner points. 16 pegs required for each tennis court.

No. 40330

## Marking lines for children's tennis

The ideal marker for small court tennis. Made of heavy, low-slip and indestructible PVC. Due to its high dead weight, the line is stumble-proof, with good ground adhesion, without fastening on the court. Additional fastening option with punched holes at both ends of the line. The marking set consists of 2 rolls, 11 m long and 8 cm wide.

No. 45000 white





## Tennis Line Speziala / Court Plus

This tennis line has been developed especially for clay courts. Made of flexible, hard PVC. With 4 mm wide lateral slits, at 28 mm intervals. The lines for double courts are supplied in 6 rolls. Hard PVC and lateral slits allow the lines and court surface to interlock perfectly. The lines are anchored with 18 ground plugs per court, which are included with all line sets. The installation of the lines can be carried out by only 1 person. Please choose the lines with the appropriate anchoring set for your needs.



### Ratchet Tensioner

Galvanized tensioner with special belts.  
No. 40371

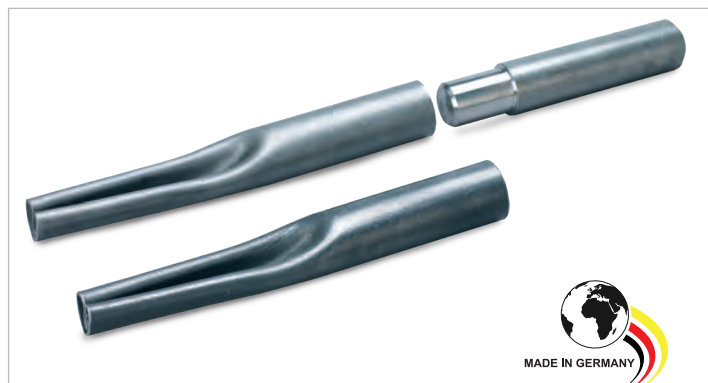

### Drive-in Peg for Anchor Tube

Made of steel. In order to avoid damages while bashing the ground anchors, it is highly recommendable to use the drive-in-peg for anchor tubes.  
No. 40376

### Anchor Tube Ground Plug

No. 40373

### Anchor Tube Floor Dowel

made from stainless steel  
No. 403730

## Tennis Line Speziala I / Court Plus I

Includes 18 anchor tube ground plugs  
4 rolls, each 24 m – 4 cm width / 1 roll, 22 m – 4 cm width  
1 roll, 17 m – 4 cm width / 1 roll, 13 m – 5 cm width  
No. 40365

## Tennis Line Speziala II / Court Plus II

Includes 18 anchor tube ground plugs  
4 rolls, each 24 m – 4 cm width / 1 roll, 22 m – 5 cm width  
/ 1 roll, 30 m – 5 cm width  
No. 40366

## Tennis Line Speziala III / Court Plus III

Includes 18 anchor tube ground plugs  
4 rolls, each 24 m – 5 cm width / 1 roll, 22 m – 5 cm width  
1 roll, 30 m – 5 cm width  
No. 40367

## Speziala 40 mm - Replacement Roll

No. 40374 17 m roll  
No. 403740 22 m roll  
No. 403741 24 m roll  
No. 403743 50 m roll



## Speziala 50 mm - Replacement Roll

No. 40375 13 m roll  
No. 403750 22 m roll  
No. 403752 24 m roll  
No. 403751 30 m roll  
No. 403753 50 m roll



### Court Plus Anchoring Set

Consists of: 18 fixing clamps, rust-proof  
No. 403530

### Fixing Clamps

Made from stainless steel. For better anchorage of the corners. Fits to all Speziala sets.  
No. 40353

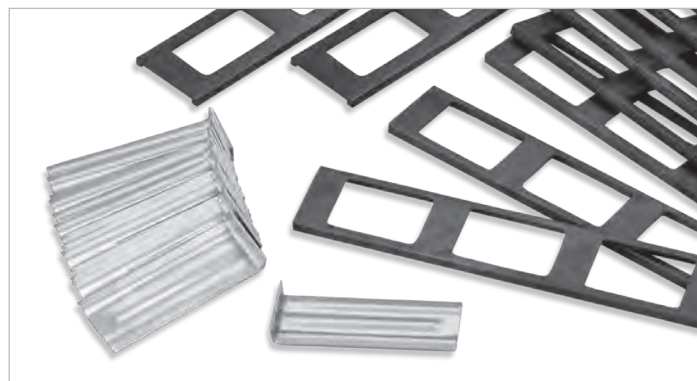

### Speziala Anchoring Set I

Consists of: 18 stainless steel tubular anchors, 16 pieces with 4 cm anchors and 2 pieces with 5 cm anchors.  
No. 403760

### Speziala Anchoring Set III

Consists of: 18 stainless steel tubular anchors, 18 pieces with 5 cm anchors.  
No. 403762

### Speziala Anchoring Set II

Consists of: 18 stainless steel tubular anchors, 8 pieces with 4 cm anchors and 10 pieces with 5 cm anchors.  
No. 403761

### Tubular Anchor

No. 40372

### End Fastener

No. 40358 4 cm



The lower part can be filled with bulk material such as gravel etc. to achieve a shock-absorbing effect. Very gentle on the joints when used in a horizontal position.

### Line Stamper

Made of plastic-coated steel. Heavy duty design to stamp in the marking lines, weight 5 kg.  
No. 40380



### Line Stamper 2

Made of steel, plastic-coated with flexible shock absorber to stump in the marking lines. Weight 5 kg.  
No. 40381

### Marking Trolley for Tennis

New product developed for children's tennis, spreading width approx. 50 mm.  
No. 45005

### Chalk for Tennis Courts

5 kg in pail  
No. 45009



### Line Roller

This roller is ideally suited for rolling in tennis court lines. The heavy weight of approx. 65 kg and the roller width of 10 cm ensures that the line is pressed in quickly and neatly. No stamping required.  
No. 40384

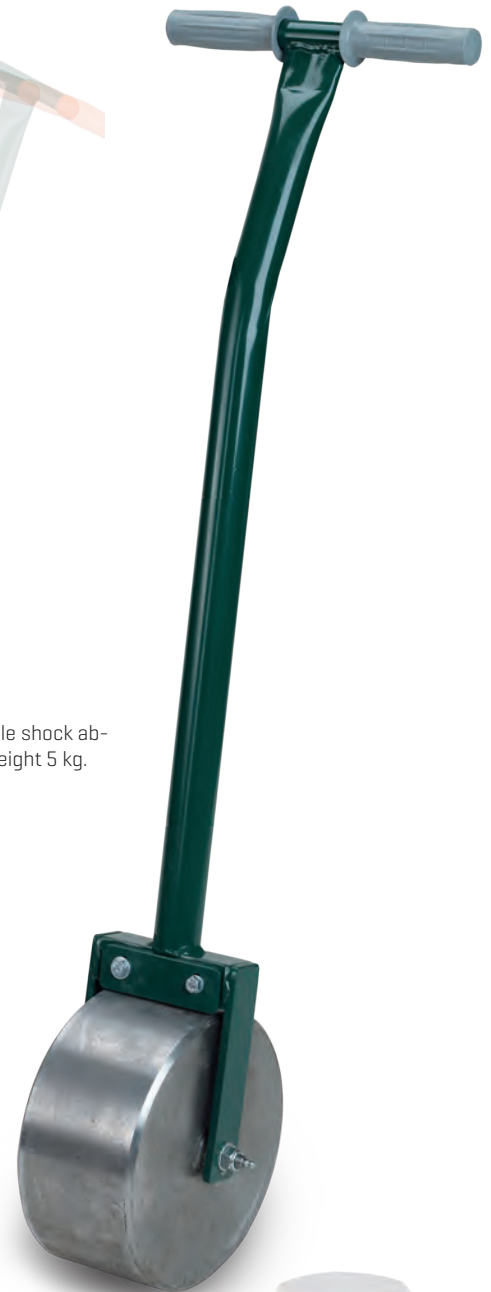

### Chalk Spray

Mipa chalk spray is ideal for touching up markings on the tennis court. The spray is a special paint that dries quickly and is environmentally friendly. It can also be easily used as a temporary marker in parking lots or other areas. The marking wears off automatically depending on weather conditions and use. In this set you get 2 bottles with 750 ml. To mark a tennis court completely, you need 2 bottles.  
No. 40522





**No Sand Shoes Sign**  
Size 300 x 300 mm.  
white plastic board.  
No. 41283



**Court Closed Sign**  
Size 300 x 200 mm, white plastic board.  
No. 412431



**Match Timer**  
The new tennis court booking clock with integrated court number, made of weatherproof plastic. Can be set to 1 hour for singles or 1 1/2 hours for doubles.  
Size 24 x 32 cm. No. 1-12 available.  
No. 41249



**Sweeping Illustration Sign**  
Size 330 x 500 mm, white plastic board.  
No. 41242



**Tennis Court Reservation Clock**  
Each player can set the clock by hand for the period he wants to book the court. Size: 40 x 40 cm  
No. 41910



**Magnetbänder**  
125 mm breit, 25 mm hoch mit Aufdruck

Nr. 41820	<b>Training</b>	Stück	€	6,00
Nr. 41830	<b>Forderung</b>	Stück	€	6,00
Nr. 41840	<b>Platzpflege</b>	Stück	€	6,00

320 - 380 mm breit, 50 mm hoch mit Aufdruck

Nr. 41780	<b>Platz gesperrt</b>	Stück	€	15,00
Nr. 41790	<b>Turnier</b>	Stück	€	19,00
Nr. 41800	<b>Trainerplatz</b>	Stück	€	19,00
Nr. 41810	<b>Alle Plätze gesperrt</b>	Stück	€	16,00



**Sign for Court Rules**  
White plastic board with sweeping illustration. No tennis court should be without this sign.  
Size 500 x 330 mm.  
No. 41241 German  
No. 412401 English



**Tennis Court Numbers**  
White rigid PVC material with black printed numbers. Numbers from 0-9, size 300 x 200 mm. Please specify the desired number when ordering. For two-digit numbers, please always specify 2 numbers.  
No. 41250

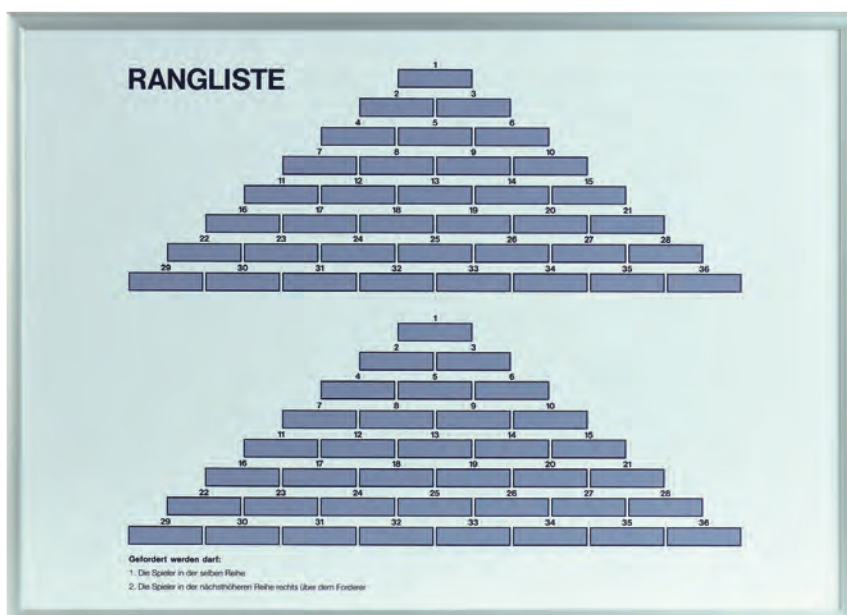

**Pyramid ranking list I**  
Sturdy sheet metal panel, galvanised and braced in an aluminium frame, with imprint on weather-resistant PVC film. Size 68 x 50 x 2.5 cm.  
No. 41970



### Court Royal Pointer Heavy II

The new generation of the Court Royal Pointer II is a further development in quality and functionality to an attractive price. The fully-moulded and deep-drawn 4 mm ABS plastic plates are very robust, weather-resistant and non-fade. 6 stable easily rotatable, non-adherent turnables with 7 cm high, clearly legible numbers are hallmarks of this top product. The Court Royal Pointer can be displayed on both sides and due to its improved design with Home and Guest, it has a better clarity. Easy attachment to the fence by included special fixing.

Size: 46 x 60 cm with 7 cm high numbers.

- No. 40832 blue
- No. 40838 green
- No. 40839 white

### Court Royal Pointer Heavy II, freestanding

The new generation of the Court Royal Pointer II is a further development in quality and functionality to an attractive price. The fully-moulded and deep-drawn 4 mm ABS plastic plates are very robust, weather-resistant and non-fade. 6 stable easily rotatable, non-adherent turnables with 7 cm high, clearly legible numbers are hallmarks of this top product. The Court Royal Pointer can be displayed on both sides and due to its improved design with Home and Guest, it has a better clarity. Stable, fillable with sand plastic base with aluminum rods for fixing the Court Royal Pointers.

Size: 46 x 60 cm with 7 cm high numbers.

- No. 408321 blue
- No. 408381 green
- No. 408391 white



### Match Pointer Scoreboard

With 6 adjustable disks for 3 set scores. Display on front and back. Clearly laid out, easy-to-read design. Sturdy, weather-resistant construction from light-resistant plastic and rust-proof hardware. Easy mounting on fence or net, complete with fence mount. International version: Local/Visit

### Model Super Big international

Size: 65 x 96 cm  
with 12 cm high numbers  
No. 408151

### Model Super international

Size: 56 x 80 cm  
with 10 cm high numbers  
No. 408141

### Model Big International

Size: 46 x 65 cm  
with 8 cm high numbers  
No. 408161

### Model Little International

Size: 35 x 50 cm  
with 6 cm high numbers  
No. 408171



### Match Pointer Scoreboard Free-Standing

With 6 adjustable disks for 3 set scores. Display on front and back. Sturdy aluminum stand with support bar and fillable plastic foot.

### Model Big green

Size: 46 x 65 cm, with 8 cm high numbers  
No. 40818

### Model Super Big green

Size: 65 x 96 cm, with 12 cm high numbers  
No. 40819



### Spare number disks

One set contains 6 disks  
No. 40811 Model Little 6 cm numbers  
No. 408110 Model Big 8 cm numbers  
No. 408115 Model Super 10 cm numbers  
No. 408111 Model Super Big 12 cm numbers



### Scoreboard Umpire Chair

To mount on all umpire chairs. Display on front and back. The umpire flips over a card after each game. Complete with mounting hardware.

No. 408305



### Scoreboard

This practical scoreboard is simply placed over the net. The numbers are flipped over to show the score from both sides. From 0 - 9, size 11 cm, incl. bag.

Size: 15 x 18 cm

No. 40835



### Umpire Chair Court Royal Deluxe

This aluminum umpire chair with European Seal of Approval DIN EN 131, meets the highest standards. The ladder with its especially wide slip-proof rungs, as well as the projecting supports with four base plates, gives this chair optimum stability. The middle plate between the ladder and the supports provides extra durability. The seat mount has an extra crossbar behind the red, UV-resistant body-contoured seat. Seat height 1885 mm, correspond to ITF, ATP und WTA Standard. No. 40809

### Umpire Chair Court Royal Tournament

Elegant aluminum umpire chair with European Seal of Approval DIN EN 131. Very robust because of the stable ladder and the projecting supports with four base plates. The seat mount has an extra crossbar behind the red, UV-resistant bodycontoured seat. Seat height 1885 mm, correspond to ITF, ATP und WTA Standard. No. 40800



### Umpire Chair Court Royal Deluxe powder-coated

Same features as model No. 40809, green, white or blue powder-coated, with green, white or blue seat.

- No. 408098 white
- No. 408099 green
- No. 408088 black



### Advertising Umpire Chair Court Royal Deluxe Grand Slam

This heavy duty chair is ideal for advertising with 2 side panels of 10 mm PVC and 3 mm panels between steps. Plastic-coated aluminum base with UV-resistant seat and PVC table. Supplied without advertising. Supplied in standard color white, also available in green or other RAL colors on request.

No. 408101 white

### 4-color digital printing

Please provide file for printing.

No. 407934

### Advertising Umpire Chair Court Royal Deluxe Grand Prix

Plastic coated aluminum chair with UV-resistant seat and PVC table, ideal for advertising. Base frame with two side panels of 10 mm PVC. Supplied without advertising. Supplied in standard color white, also available in green or other RAL colors on request.

No. 408100 white

### 4-color digital printing

Please provide file for printing.

No. 407941



### Ambrella for Umpire Chairs

Very solid, tiltable parasol, 150 cm diameter with a quick release device, including fittings.

- No. 408005 red
- No. 408011 green
- No. 408012 blue



### Seat Court Royal

- No. 408148 green
- No. 408150 red
- No. 408149 white
- No. 408147 blue



Seat red  
No. 40771



### Writing board

white, 550 mm x 15 mm x 10 mm.  
Nr. 408097





### Players' Bench Grand Slam Aluminum 150 cm long

The bench is an ideal advertising medium and is used worldwide at international tennis tournaments and in football stadiums. High-quality aluminum construction, white powder-coated. The seating surface consists of 5 multi-chamber profile slats, supplied in four parts, easy assembly. The 10 mm PVC advertising panels are preassembled without an advertising logo. Weight 27 kg. No. 41222 white

### 4-color digital printing

Please provide file for printing.  
No. 412221



### Advertising Bench Freiburg GFK 150 cm

2 all-plastic legs and 5 multi-chamber plastic slats serving as a seat and a KU backrest for easy attachment of advertising stickers. This exclusive, high-quality GFK model is very robust and specially developed for extremely hot regions. No. 41208 white

### 4-color digital printing

Please provide file for printing.  
No. 412209



### Umbrella Nuovo

Very solid, tiltable parasol, 150 cm diameter with a quick release device. 8 pieces, made of 100% polyester fabric, approx. 160g/qm, weatherproof. Fits the umbrella holder for plastic benches as well as the Robusto umbrella stand.  
No. 408009 red  
No. 4080091 green  
No. 4080092 blue

### Umbrella Stand Sun

Very stable umbrella stand made of plastic, with rotatable support that can be adapted to different diameters. The stand can be filled with water or sand. Dimensions: 45 x 46 cm  
No. 408182



### Umbrella holder for plastic benches

From now on you are sitting in the shade. The new umbrella holder, made of aluminum, can be screwed onto the existing screws of the benches Köln, Freiburg and Berlin. Suitable for umbrellas with a diameter of 25 mm. No. 4080097



MADE IN GERMANY



### Umbrella Holder for Players' Bench

Made of white, powder-coated aluminum, with fittings for easy mounting. No. 408007







## Fantastic aluminium bench with 4 seats

This modular system allows for an enormous variety of club colours. The frame is made of natural aluminium and is equipped with a sturdy cross strut.

The bench is UV-resistant and absolutely weatherproof thanks to the water drainage on the seat shells. The bench is easy to transport thanks to its low weight. Screws for fastening and cover caps are included.

Height: 900 cm Width: 450 cm Length: 1960 cm  
No. 41221



## Deluxe Tennis Bench

Our newly designed tennis court bench has everything you could wish for.

Plenty of space (approximately 100 x 45 cm) in the middle for bags and rackets, two comfortable seats, with plastic-, weather- and light-resistant seat pads, 57 cm wide and 50 cm deep. Super robust design. A first class product.

No. 41213 white



## Bench Hohenzollern

Elegant, yet extremely robust bench for tennis courts and outdoor use. With armrests, seat width 150 cm, seat depth 50 cm. Solid plastic construction with integrated, stainless steel brackets. Seat and back are supplied preassembled to make setting up easier.

No. 412012 white

## Bench Cologne 120 cm long, white

2 plastic legs and 9 multi-chamber plastic slats, foldable. Proven high-quality. Weight approx. 13 kg.

No. 412233 white

No. 412234 green



**Bench Munich** 150 cm long, white  
2 plastic legs and 5 multi-chamber plastic slats, without backrest and therefore usable from both sides. Practical and comfortable to sit on. Weight approx. 9 kg.  
No. 412210 white



**Bench Munich** 150 cm long, green  
2 plastic legs and 5 multi-chamber plastic slats, without backrest and therefore usable from both sides. Practical and comfortable to sit on. Weight approx. 9 kg.  
No. 412211 green



**Bench Freiburg** 150 cm long, white  
2 plastic legs and 9 multi-chamber plastic slats with reinforcement bracket in the center, foldable. Proven high-quality. Weight 15,5 kg.  
No. 411991 blue



**Bench Freiburg** 150 cm long, green  
2 plastic legs and 9 multi-chamber plastic slats with reinforcement bracket in the center, foldable. Proven high-quality. Weight 15,5 kg.  
No. 41200 white  
No. 41199 green



**Bench Helgoland** 150 cm long, white  
2 plastic legs and 12 multi-chamber plastic slats with reinforcement bracket in the center, foldable. Practical and comfortable to sit on. Weight approx. 21 kg.  
No. 412071 blue



**Bench Helgoland** 150 cm long, green  
2 plastic legs and 12 multi-chamber plastic slats with reinforcement bracket in the center, foldable. Practical and comfortable to sit on. Weight approx. 21 kg.  
No. 41203 white  
No. 41207 green



**Bench Stuttgart** 200 cm long, green  
3 plastic legs and 5 multi-chamber plastic slats, without backrest therefore usable from both sides. Practical and comfortable to sit on. Weight approx. 11,5 kg.  
No. 412212 white  
No. 412213 green



**Bench Berlin** 200 cm long, green  
3 plastic legs and 9 multi-chamber plastic slats, foldable. Proven high-quality. Weight 18,5 kg.  
No. 412111 blue  
No. 412110 white  
No. 41211 green



**Bench Sindelfingen** 200 cm long, white  
3 plastic legs and 12 multi-chamber plastic slats. Practical and comfortable to sit on. Weight approx. 26 kg.  
No. 41204 white  
No. 41212 green

## Brush Shoe Cleaner Ideal

Made of zinc-coated steel with high-quality bristles. Ideal cleaner for sand and clay courts. 600 x 400 mm.  
No. 41284

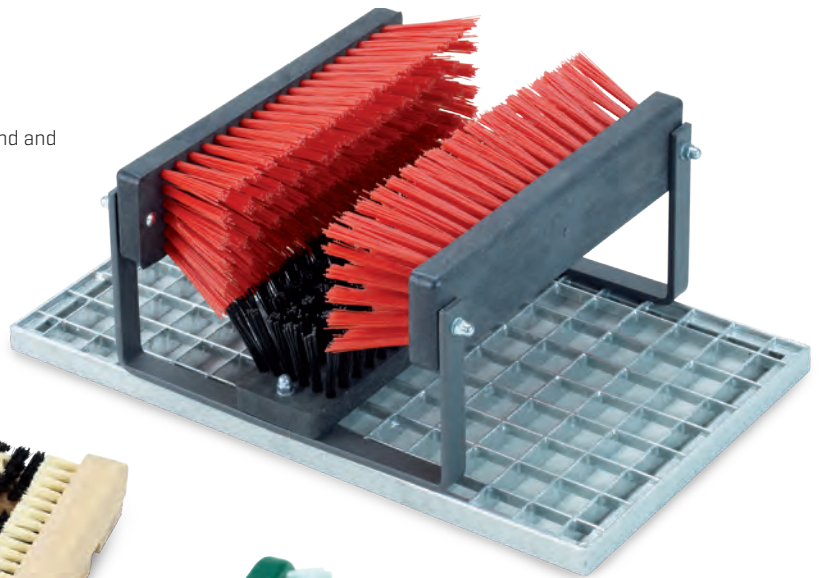

## Tennis Shoe Cleaner wood

Made from polished beech wood. Size 360 x 270 mm. Extremely durable non-slip construction.  
No. 41269



## Tennis Shoe Cleaner Little

Solid plastic construction. Size 270 x 350 mm  
No. 41271

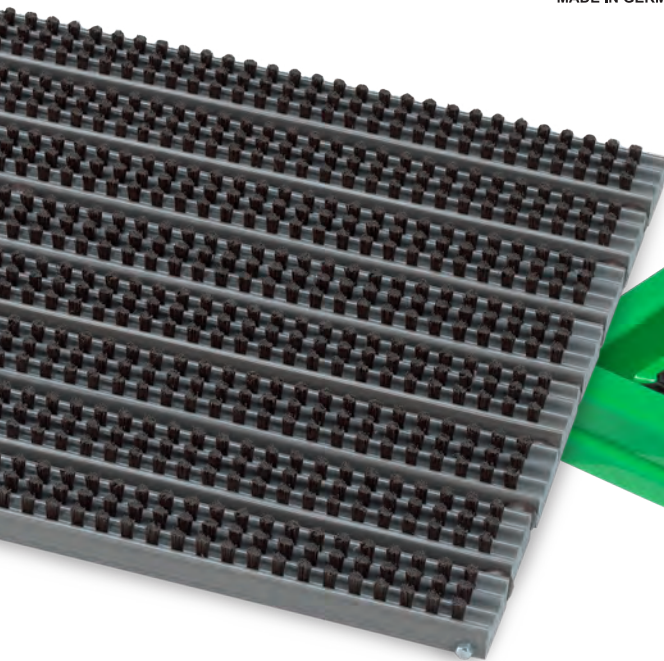

## Shoe Cleaning Mat Atlantis

A solid, stiff brush mat made of recyclable synthetic material. Width: 590 x 380 x 30 mm.  
No. 41280



## Shoe Cleaning Tub

The perfect cleaner for all kind of sports shoes. Fine sprays of water in the punched rubber mats clean the soles of the shoes when triggered by the person's weight. Can be used for clay, granule and sand courts. Dirt remains in the tub. Easy to clean.  
Size 600 x 500 mm.  
No. 41286



### Waste Bin 50 I

UV-resistant plastic waste bin. Heavy-duty hot galvanized metal fixture for fastening to poles, railings or walls. Complete with hardware and key.

No. 41233 green  
No. 41234 orange



### Designer Waste Bin „Tennis Ball“

In the shape of a tennis ball, approx. 50 cm Ø. Made from top-quality special plastic. Completely UV and weather-resistant. Hinges and fastening materials made from stainless steel. Hinged lid. Standard version with 2 quick-release straps for mounting on poles, railings or walls.

No. 41224 yellow  
No. 41223 green

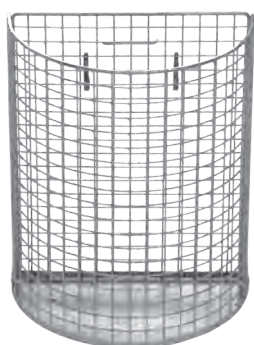

### Wire Waste Bin 18 I

Semi-circular, galvanized with perforated metal base to drain water. Spring hooks for fastening to fence. Size: height 14 cm, width 32 cm, depth 17 cm.

No. 41236

Alle Preise verstehen sich inkl. gesetzlicher MwSt..

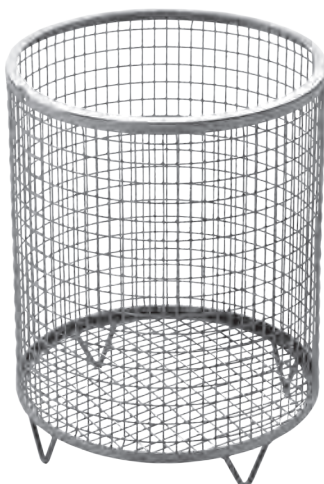

### Wire Waste Bin 63 I

2 mm sturdy, strong hot-galvanized frame. 4.8 mm round steel legs. Size: 40 cm Ø; height 50 cm.

No. 41277

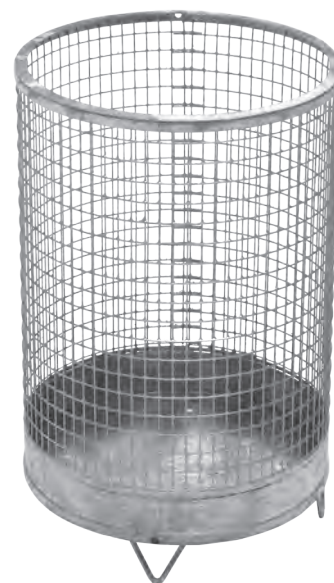

### Wire Waste Bin 75 I

2 mm strong hot-galvanized frame with 4.8 mm round steel legs. Metal base with holes for water drainage. Size: 40 cm Ø; height 60cm

No. 41278





**The quality screen, tried and tested thousands of times worldwide.**

Heavy polyethylene fabric, UV-stabilised, wind-permeable. Reinforced all round with eyelets every 50 cm, therefore particularly tear-resistant.

**Screen Super** Die Qualität Super wiegt 160 g/qm, ist winddurchlässig und in den Farben hell- und dunkelgrün erhältlich. Es ist die meistverkaufte Sichtblende.

**Screen Exklusiv** The Exclusive quality weighs 140 g/sqm, is extremely wind-permeable, ideal for printing and available in the colours light green, dark green, yellow, white, blue, red and black. It is available in 12 x 2 m but also up to a length of 50 m and a width of up to 4 m.

**Printing** Our covers are printed with special UV-resistant colours. This ensures particularly good adhesion and long durability. As standard, the covers are printed in black. Other print colours are subject to a 25 % surcharge.

All company logos, logotypes and lettering can be produced on request. Photo prints are also possible.

The prerequisite for production is the delivery of a printable file (vectorised or print PDF) by the client. Production only after approval of the control template (PDF).



**Padelcourt Screen Digimash**

4C digital print.  
With silver-coloured eyelets every 50 cm.

Dim.: 1850 mm x 900 mm

Delivery incl. snap hook

No. 41526 Single-sided printing

No. 41527 Double-sided printing



**Fastening - S - Hook**

Thickness 4 mm, length 56 mm, width 18 mm

No. 41520

**Spring Hooks**

Galvanized, 60 hooks needed for 2 x 12 screen

No. 41530



**Farbmuster Sichtblende Exklusiv Color**

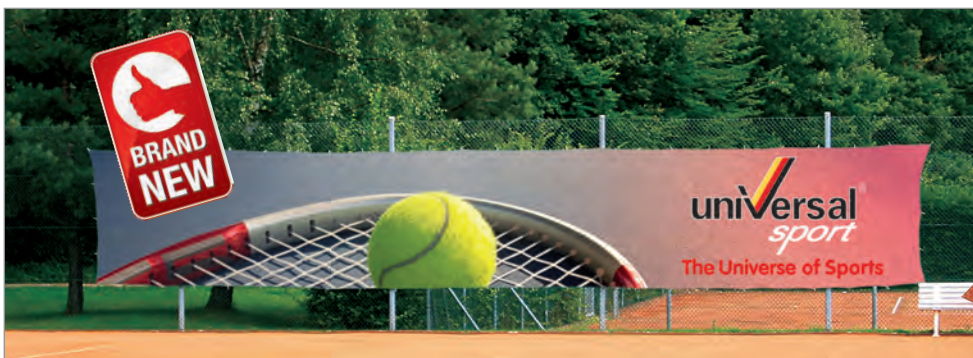

**Sreen Digimash**

Digital photo print in 4C from photorealistic originals. With silver-coloured eyelets every 50 cm. Dimensions: 12 m x 2 m.

No. 415176

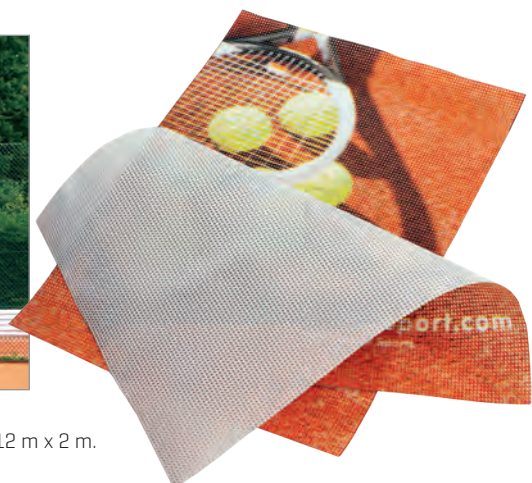



### Wind Screen Light Green Super

With metal eyelets every 50 cm.  
 No. 415115 Dimensions: 12 m x 2 m  
 No. 415103 Dimensions: 17 m x 2 m  
 No. 415119 Dimensions: 16 m x 3 m  
 No. 415104 Dimensions: 18 m x 3 m



### Wind Screen Dark Green Super

With metal eyelets every 50 cm.  
 No. 415105 Dimensions: 12 m x 2 m  
 No. 415109 Dimensions: 17 m x 2 m  
 No. 415116 Dimensions: 16 m x 3 m  
 No. 415113 Dimensions: 18 m x 3 m



### Wind Screen Exklusiv Color

With metal eyelets every 50 cm. Dimensions: 12 m x 2 m.  
 No. 41510 dark green  
 No. 41511 light green  
 No. 41512 blue  
 No. 41513 white  
 No. 41514 black  
 No. 41515 yellow  
 No. 41516 red



### Wind Screen Exklusiv with Advertising Printing

With metal eyelets every 50 cm. Color: light green or dark green  
 Dimensions: 12 m x 2 m.  
 No. 415171 printing up to 40%



### Wind Screen Exklusiv with Advertising Printing

With metal eyelets every 50 cm. Color: light green or dark green  
 Dimensions: 12 m x 2 m.  
 No. 415172 printing up to 60%



### Wind Screen Exklusiv with Advertising Printing

With metal eyelets every 50 cm. Color: light green or dark green  
 Dimensions: 12 m x 2 m.  
 No. 415173 printing up to 80%



### Wind Screen Super with imprint Universal Sport

With metal eyelets every 50 cm. Dimensions: 12 m x 2 m.  
 No. 41500 dark green  
 No. 41501 light green



### Wind Screen Super with imprint Court Royal

With metal eyelets every 50 cm. Dimensions: 12 m x 2 m.  
 No. 41503 dark green  
 No. 41504 light green

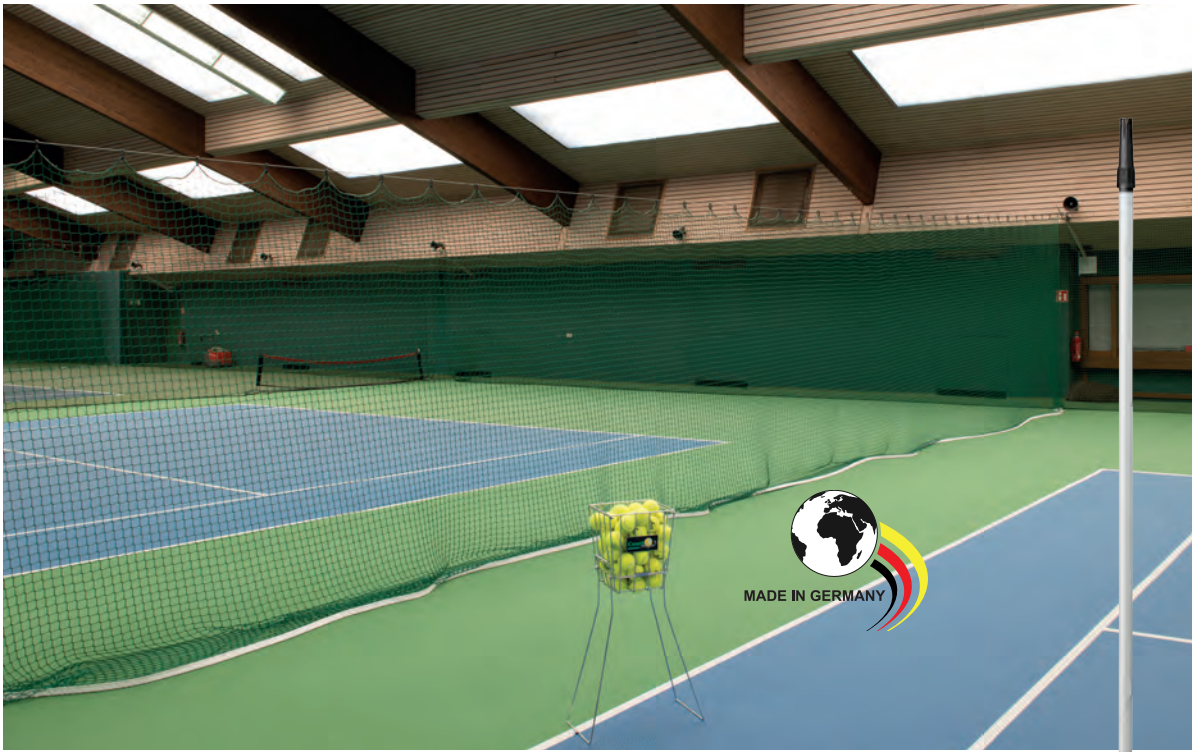

## Standard Dividing Net

Robust polyethylene net 2.4 mm thick, mesh width 4.5 mm. For tennis hall and outdoor use. Complete with steel wire, approx. 4 mm thick, 38 m long, 1 tension lock, lead cord weighs 200 g/m and nylon guide rings, 3 rings to be fitted to the net per meter.

Size 40 x 2,5 m

- No. 41570 white
- No. 41571 green
- No. 41572 black

Size 40 x 3 m

- No. 41580 white
- No. 41581 green
- No. 41582 black

## Support Rod

Made of aluminum, with large support base, free-standing. Freely adjustable by telescopic mechanism from 2 m to 3 m. 3 support rods are needed to support the standard dividing nets.

No. 41585



## Dividing and Stop Nets 2,3 mm

Made of high-strength polypropylene, mesh width 45 mm.

No. 41590 white



## Dividing and Stop Nets 2,3 mm

Made of high-strength polypropylene, mesh width 45 mm.

- No. 41600 green
- No. 41591 black



## Dividing and Stop Nets 3 mm

Made of high-strength polypropylene, mesh width 45 mm.

No. 41610 green

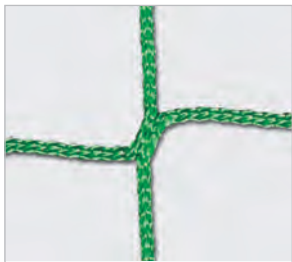

## Dividing and Stop Nets 4 mm

Made of high-strength polypropylene, mesh width 45 mm.

No. 41611 green

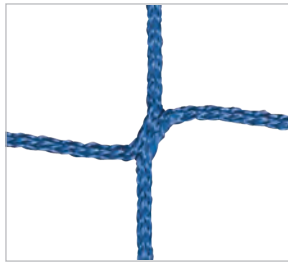

## Dividing and Stop Nets 4 mm

Made of high-strength polypropylene, mesh width 45 mm.

No. 41613 blue

## Lead Cord

Directly sewn to the net as weighting

- No. 41620 200g
- No. 41621 400g

## Plastic Guide Rings

Made of nylon, black, 3 integrated in the net for each meter

No. 41630

## Wire

Made of zinc-plated steel

- No. 41640 4 mm
- No. 41641 6 mm

## Tensioning Set

Eye rings and tension lock each end

- No. 41650 for 4 mm
- No. 41651 for 6 mm

**Additional charge for small orders per single net:**

- nets of less than 5 sqm + 100%
- nets of less than 20 sqm + 20%
- nets of less than 10 sqm + 35%

Alle Preise verstehen sich inkl. gesetzlicher MwSt..







### Standard Dividing Net Super black

The newly developed knotted dividing net with a material thickness of 1,6 mm for indoor and outdoor use is absolutely weather-resistant and extremely tearproof. Due to the colour black and the thin material the net is more transparent than the conventional dividing nets. The mesh size is 4,5 cm. Complete with 38 m long steel wire and 2 tension locks. 200 g/m cord weighs and 3 galvanized snap hooks per meter. Size 40 m x 3 m  
No. 42500

### Broom for Granular Surfaces (above)

Broom with Arenga bristles for hall floors with rubber granular. The special position of the bristles guarantees an even sliding of the broom. Complete with a very sturdy aluminum handle in three parts. Working width 200 cm.  
No. 41075

### Granu-Top Broom (below)

This is the perfect broom for cleaning granular surfaces. The bent ends of the broom and the position of the bristles guarantee an even spread of granules. The static supercharge cleans debris abraded from the balls and lint from the surface. Complete with aluminum handle and weights on both ends.  
Working width 200 cm.  
No. 41076

### Replacement Brush for Granu-Top

No. 410761

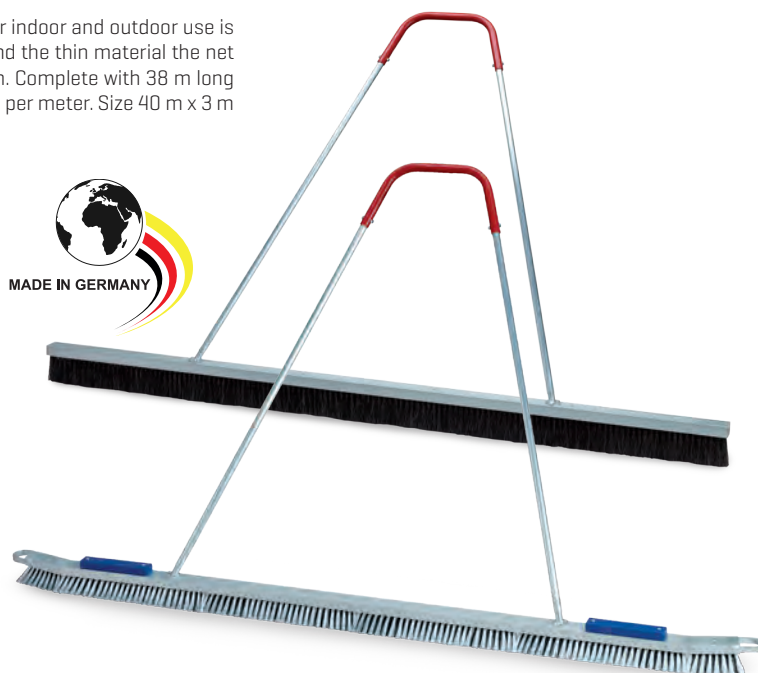

## Compact

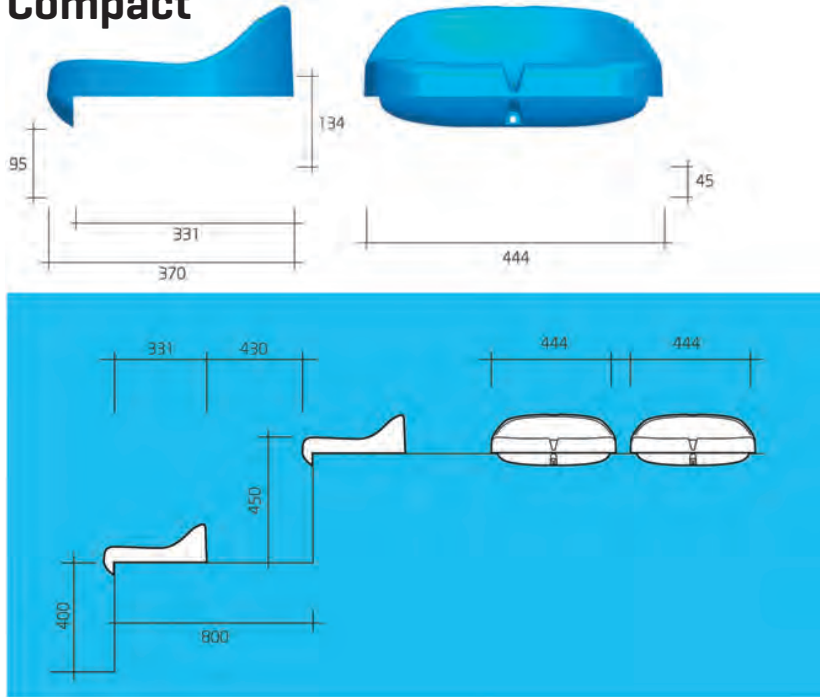

### Tribune Seat Compact for Self Assembly

Made of moulded, shock-resistant, UV-resistant polypropylene. Fast and simple assembly on nearly every underground due to triple fittings. The attachment points are protected against vandalism. All seat shells are equipped with a water drain. Available in the colours: black, white, orange, green, blue, yellow, red, grey. Please indicate the colour. For an additional charge, the seats can be numbered [flame-retarding on request].  
Weight: 0.810 kg



No. 409628 PANTONE 3686



No. 409629 RAL 5002



No. 40962 RAL 9017



No. 409621 RAL 9016



No. 409622 RAL 2008



No. 409623 RAL 60017



No. 409624 RAL 5015



No. 409625 RAL 1018



No. 409626 RAL 3000



No. 409627 RAL 7001

Alle Preise verstehen sich inkl. gesetzlicher MwSt..

## Elegance

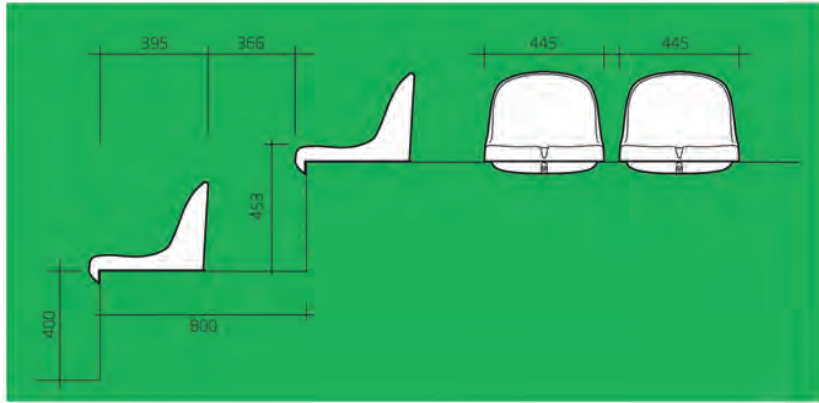
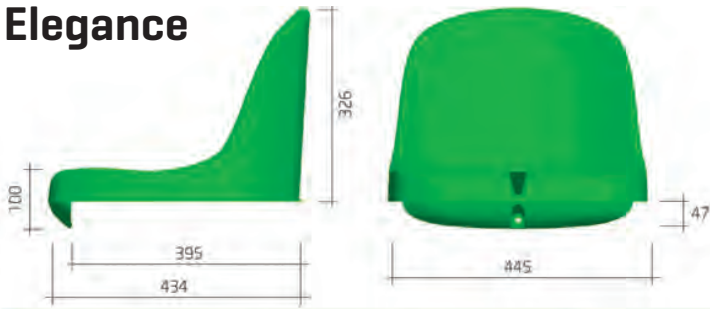

### Tribune Seats Elegance for Self Assembly

Made of moulded, shock-resistant, UV-resistant polypropylene. Fast and simple assembly on nearly every underground due to triple fittings. The attachment points are protected against vandalism. All seat shells are equipped with a water drain. Available in the colours: black, white, orange, green, blue, yellow, red, grey. Please indicate the colour. For an additional charge, the seats can be numbered (flame-retarding on request).  
Weight: 1.930 kg



No. 409638 PANTONE 3686



No. 40963 RAL 9017



No. 409631 RAL 9016



No. 409632 RAL 2008



No. 409633 RAL 60017



No. 409634 RAL 5015



No. 409635 RAL 1018



No. 409636 RAL 3000



No. 409637 RAL 7001

Alle Preise verstehen sich inkl. gesetzlicher MwSt.





### Court Royal tribune with 50 seats, three rows, indoor and outdoor

The exclusive Court Royal tribune for all outdoor sports with 50 comfortable seats in three rows as well as a 9.19 m x 2.13 m centre aisle and railings.

The construction is made of steel profile tubes and heavy gratings as floor covering. All steel parts are hot-dip galvanised and completely weatherproof. The UV-resistant plastic bucket seats offer comfortable seating and can be supplied in various colours. The grandstand is supplied in 4 modules width of 2 m with 12 seats as well as a 1.2 m wide stair module with 2 seats for easy assembly on site and complies with DIN 13200. Available colours: see pages 64-65

No. 40985

#### Technical data:

Length:	9.19 m
Depth:	2.13 m
Height:	1.52 m
Seat height:	0.84 m
Capacity:	50 seats
Stand material:	hot-dip galvanised steel
Seat material:	injection-moulded polypropylene, impact-resistant, UV-resistant

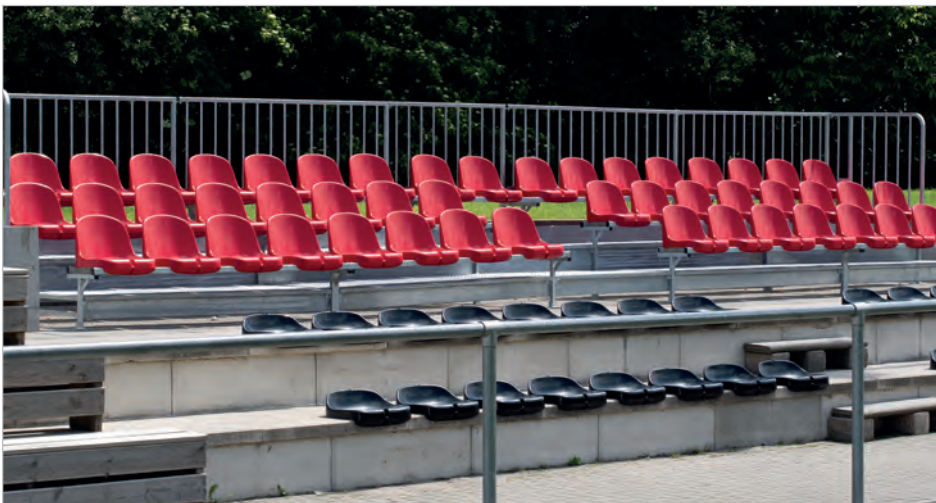

### Court Royal tribune roofing for self-assembly as a kit

The stable substructure is made of anodised, corrosion-resistant aluminium profiles measuring 160 x 100 mm. The roof is made of impact-resistant, UV-resistant and heat-repellent polycarbonate in the colour smoked glass grey. Drainage is via a gutter with a downpipe, which is included in the scope of delivery. Thanks to the high-quality materials used, the canopy is corrosion-resistant, durable, hail-proof and frost-proof.

No. 40987

#### Technical data:

Length:	9.83 m
Width:	2.73 m
Height:	2.94 m





## Tribüne Universal Flex mit 24 Sitzen, indoor und outdoor mit Rollen

- flexibel einsetzbare Tribünenkonstruktion aus Aluminium
- verschraubbar als Bausatz
- Maße circa: L 4,0 m x T 2,0 m x H 1,10 m
- mit Transportrollen aus Polyamid zum einfachen Versetzen der Tribüne
- 24 Einzelsitze



**Nr. 40988** Preis inkl. Sitze, Lieferung frei Haus innerhalb Deutschlands € 6.060,00

Wählbare RAL-Farben:

schwarz (9017)	weiß (9016)	grün (6001)
blau (5015)	gelb (1018)	rot (3000)

oder Farbkombinationen

## Mobilissima indoor tribune

The Mobilissima can be used indefinitely. The high assembly speed means that up to 50 seats are available per unit! You can increase the number of seats as required by adding as many sets as you like, and the grandstand only requires a minimum storage space of approx. 3.8 m<sup>2</sup> for storage. The elements are delivered pre-assembled. All that remains to be done is to screw on the castors. The advantage: quick and easy to move and set up by one person. Steel construction RAL 7016 [PU-coated]; seat surfaces made of glued multi-layer wood panels, natural beech, 2\* treated with DD lacquer, edges sanded and sealed colourless. Treads and steps made of glued plywood, natural beech, 2 x treated with DD lacquer, tread edges sanded and sealed colourless, polyamide castors Ø 100 mm, runners with hard-wearing felt covering.

No. 409651 indoor, without preassembly

No. 409661 outdoor, with preassembly

### Technical data

Length: 875 cm  
 Height: 185 cm  
 Width: 180 cm  
 Weight per set: approx. 500 kg

### Contents of delivery

- 5 grandstands with different lengths
- 5 rear railings
- 2 side railings
- Operating instructions



# Training Walls + Ball Machines





## Air-Tennis practice wall

The recently developed Air-Tennis tennis practice wall is the ideal training partner for everyone, from beginners to experts. This product is a unique and absolutely unbeatable piece of training equipment for use in stationary or transportable mode. It comes in a bag and is easy to transport. To set it up, simply unfold it on the ground and roll it out. Use the bellows [supplied], then fill it with air - it just takes seconds. You can use the air pressure gage, also supplied, to check that the air pressure is at the right level, as this also affects the way the ball bounces back. There are also attachment straps on both sides for attaching the practice wall to our pairs of stands, fences, or sports hall walls. You can also empty it in seconds, simply by turning over the bellows. Players can play on both sides of the Air-Tennis practice wall. It has lines marked on it at the height of the net to guide the player. Tested by international trainers who rated it very highly.



### Air-Tennis practice wall 3 m

300 x 200 cm  
No. 42020 without stand

### Air-Tennis practice wall 4 m

400 x 200 cm  
No. 42021 without stand

### Air-Tennis practice wall 5 m

500 x 200 cm  
No. 42022 without stand

### Air-Tennis practice wall 6 m

600 x 200 cm  
No.42023 without stand

### Air Tennis practice wall set

300 x 180 cm complete with stands  
No.42025

### Pair of stands

No. 42024

### Repair kit

No. 42027





## Smash-Back Training Wall

Made of acrylic and frostproof concrete. Homogeneously sealed green coating offers additional protection. Parabolic playing surface guarantees a spot-on ball rebound. The white marking lines are indestructible. This training wall is simply mounted and bolted to a strip foundation with recessed anchor bolts. Can be supplied in two heights, 230 and 300 cm with a 100 cm protective screen. Width individually adjustable with elements. Integration of sound-proofing, recommended in residential areas.

### Typ II E

Playable on one side. Height 230 cm, element width 148 cm, without protective screen.

No. 42060

### Typ I E

Playable on one side. Height 300 cm, element width 100 cm, without protective screen.

No. 42062

### Protective screen Typ E

For single-sided playing walls. Hot galvanized, angled ball protective screen. 100 cm high.

No. 42064



### Noise Reduction Type I an II E

For single-sided playing walls, 2,30 and 3,00 m. Prefabricated acrylic concrete slabs with covering and insulating materials.

No. 42066

**Side panelling** for Smash-Back rebound wall

No. 42068







## Tennis Tutor ProLite

The wide speed range makes this machine a superb choice for all beginners. Due to the small size and light weight it can be stored easily and fits in almost all car trunks. A good choice for sports lessons in schools as well as for private use. The ball trajectory is manually adjustable from groundstroke to towering lob. The oscillator delivers shots randomly across the court.

### Technical details:

Ball capacity:	125 balls
Dimensions:	[HxWxD]: closed 31 x 50 x 46 cm
Weight:	13 kg
Power:	battery
Playing time:	2 - 3 hours
Recharging time:	12 hours
Feeding interval:	1.5-10 sec.
Top speed:	96 km/h
Ball flight:	stop to lob
Line-directions:	1 direction and random
Case:	plastic
Remote control:	no - on-off switch

No. 42013

## Tennis Tutor Plus

The ball machine Tennis Tutor PLUS is battery operated. It is portable and rollable like a suitcase when the handle is pulled out. The ball speed is adjustable from a light throwing ball for beginners to a high-speed ball for advanced players. The trajectory can be set between net roller and lob, regular ball sequence and arbitrary scattering angle.

### Technical details:

Ball capacity:	150 balls
Dimensions [HxWxD]:	51 x 50 x 50 cm
Weight:	21,6 kg
Power:	battery
Playing time:	4-6 hours
Recharging time:	12 hours
Feeding interval:	1,5-10 sec.
Top speed:	136 km/h
Ball flight:	short to long
Line-directions:	topspin, spin,flat,slice
Ball spin:	one direction and random
Housing:	plastic
Remote control:	yes on/off

No. 42012



## Tennis Twist

Especially designed for children and beginners. The Tennis Twist can be used in clubs and schools as well as in backyards, driveways and even basements. The machine is very easy to use - just turn it on and it shoots a ball every five seconds. The arc of the ball can be adjusted anywhere from approx. 3 - 6 meters.

### Technical details:

Ball capacity:	28 balls
Dimensions [HxWxD]:	50 x 20 x 20 cm
Weight:	5 kg
Power:	battery
Playing time:	5-6 hours
Feeding interval:	5 sec.
Top speed:	15 km/h
Ball flight:	straight
Lines-directions:	1 direction
Ball spin:	no
Case:	plastic
Remote control:	no on-off switch

No. 42016



# Training Walls + Ball Machines

## Ball machine Playmate VOLLEY DREAM

The ball machine Playmate Volley Dream is a high-quality portable ball throwing machine with aluminum housing and battery operation. It meets the highest safety requirements. There is a sensor installed, which immediately stops the ball ejection if a person stands in the immediate vicinity in the ejection direction. Furthermore, the new Volley Dream comes with a lockable lid, which must be locked for safety reasons in game mode. It can be set in seven directions. For example: right, middle, left, left right, right, middle. Likewise, it plays top spin and slice, as well as short-long. The ball sequence can be adjusted continuously to 6-60 pieces of balls per minute. An ideal device for individual or group training. Exact throwing accuracy and quiet running. With the newly integrated accessory „i-Playmate“ you can use an App to control the Playmate i-Smash via the i-Phone or i-Pad, as well as record, document and compare your training achievements.

### Technical data:

- Capacity: about 180 balls with lid closed.
- Dimensions: (height x width x depth) 64 x 56 x 48 cm
- Weight: 31 kg
- Power connection: battery operation (charging current 230 V)
- Battery life: min 4 hours
- Charging time: 6 hours
- Top speed: 140 km / h
- Ball sequence: 1 - 10 sec.
- Trajectory: short-long, infinitely adjustable Ball Types Top Spin, Slice
- Ball Types: Top Spin and Slice
- Spread angle: 7 directions right-left-center
- Housing: aluminum with lockable lid
- Safety: Shut down sensors
- Remote control: wireless, on / off

No. 42005



## Remote Control Playmate

General remote control for all Playmate ball machines.

No. 420342



## Charger

For Playmate Transportable

No. 420033



## Power Pack

For Playmate Transportable

No. 420032

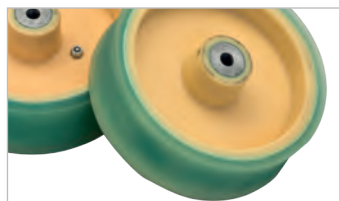

## Ejection Wheels

For Playmate Transportable

Diameter: 15,3 cm

No. 420031



## Ejection Wheels

For Playmate ACE and i-Smash

Diameter: 20 cm

No. 420341



## Covering Hood

For all Playmate Ball Machines

No. 42004 for Playmate Volley Dream

No. 42031 for Playmate-i-Smash Dream

## Ball machine Playmate i-Smash DREAM

The ball machine Playmate i-Smash is the highlight of the ball throwing machines. It meets the highest safety requirements. A sensor is installed, which stops the ball ejection immediately, if a person stands in direct proximity in ejecting direction. Furthermore, the new i-Smash will be delivered with a lockable lid, which must be made for safety reasons.

It can be set in seven directions. For example: right, middle, left, left right, right, middle. Likewise, it plays top spin and slice, as well as short-long. The ball sequence can be adjusted continuously to 6-60 balls per minute. An ideal device for individual or group training.

Exact throwing accuracy and quiet running. The housing is made of powder-coated aluminum. With the newly integrated accessory „i-Playmate“ you can use an App to control the Playmate i-Shmash via the iPhone or i-Pad, as well as record, document and compare your training achievements.

### Technical data:

- Capacity: about 240 balls with lid closed.
- Dimensions: [height x width x depth] 96 x 54 x 92 cm
- Weight: 35 kg
- Electricity: 230 V
- Top speed: 150 km / h
- Ball sequence: 1 - 10 sec.
- Trajectory: short-long, infinitely adjustable Ball Types Top Spin, Slice
- Ball Types: Top Spin and Slice
- Spread angle: 7 directions right-left-center
- Housing: aluminum with lockable lid
- Safety: Shut down sensors
- Remote control: wireless, on / off

No. 42008



## Playmate MOVER

This new ball collector collects all spread out balls in shortest time. Basket can be removed easily and emptied into the ball trolley or ball machine. The tentacles are retractable.

High quality aluminum construction with big wheels. Basket can be hooked to the handle when balls are played.

No. 42076



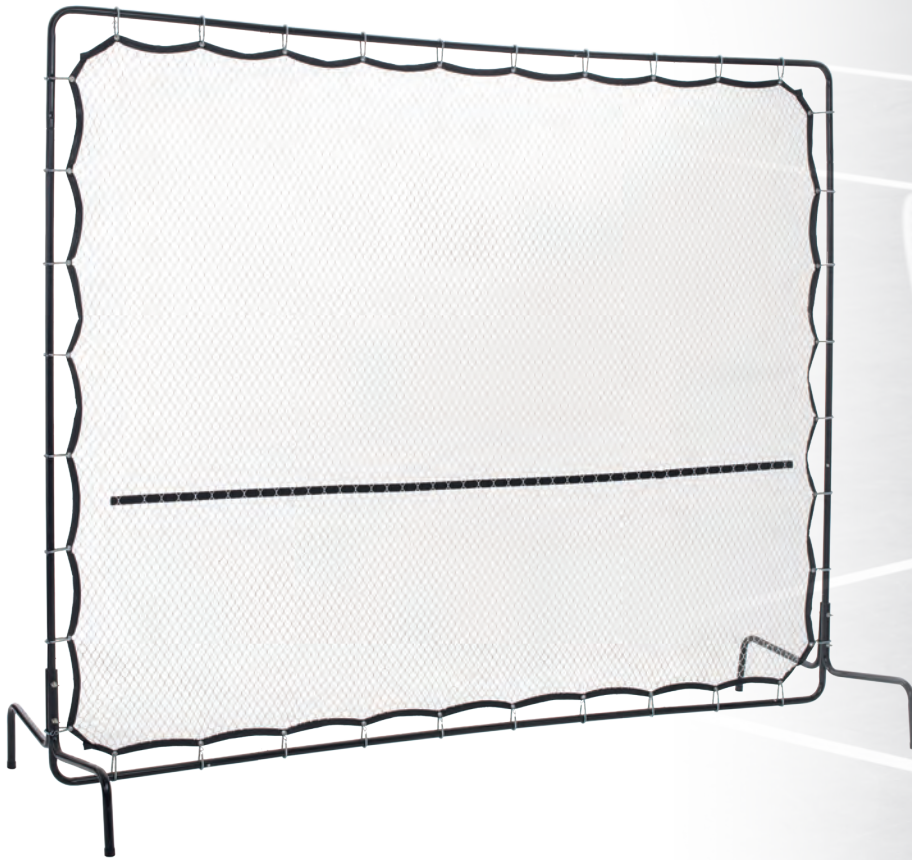

### **Tennis Net Training Wall**

Transportable net wall of enameled tubular steel.  
Infinitely adjustable, for different  
ball variations. Size: 2.80 x 2.20 m.  
No. 42040

### **Replacement Net** for Tennis Net

Training Wall 2.60 x 2.0 m.  
No. 42041

### **Replacement springs**

No. 42037



# Training Devices





**Tripod** for  
Multi Sports Radar  
No. 43002

### Multi Sports Radar

This new speed control measuring instrument can be used for tennis, golf, football and many other ball games. The ball speed can be displayed within a few seconds.

Including mini tripod and bag.

Technical Data:

- Speed control from 5 to 199 km/h or 3 to 150 m/h
- Measuring distance from 1-12 m
- Three-figure LED-display with 55mm high digits
- Voice-announcement of the displayed digits is adjustable
- On the average batteries without voice are non-perishable ca. 50h, batteries with voice ca. 30h.
- Automatic switch-off- function for saving the batteries
- 5 AA batteries are needed (Not contained in consignment).
- Suitable for all tripods
- Dimensions: 18 cm x 15 cm x 12 cm

No. 43003



Use this QR-code for downloading the instruction movie

### Tennisball Collector K-MAX

The K-MAX is the fastest ball collector. Simply roll up the balls and empty them with the opening mechanism into the ball basket. This makes fun und you only lose little time. The K-MAX only weighs 3kg including an aluminum handle with suspension and it has a capacity of 60 balls.

No. 42125



### CLAX® Ball Trolley

This newly developed trolley is essential for all tennis trainers. Due to the use of aluminum and a high-grade plastic, a high durability is guaranteed. The easily smooth-running wheels are bearing mounted and are equipped with lever brakes. Foldable within seconds. Storable in almost all trunks. A 46 l folding box is included but any other 32 or 46 l boxes can also be used. The boxes can be transported on the upper as well as on the lower platform. Load capacity of upper level 20 kg and the lower platform 40 kg. Dimensions:  
Completely opened: [L x W x H] 55 x 103 x 89 cm, folded together: [L x W x H] 55 x 71 x 18 cm  
Cage Height: 85 cm, Cage size: [L x W x H] 60 x 34 x 26 cm  
Capacity: 120 balls, Weight: 10 kg  
No. 26000

### Replacement box for CLAX trolley

No. 26001

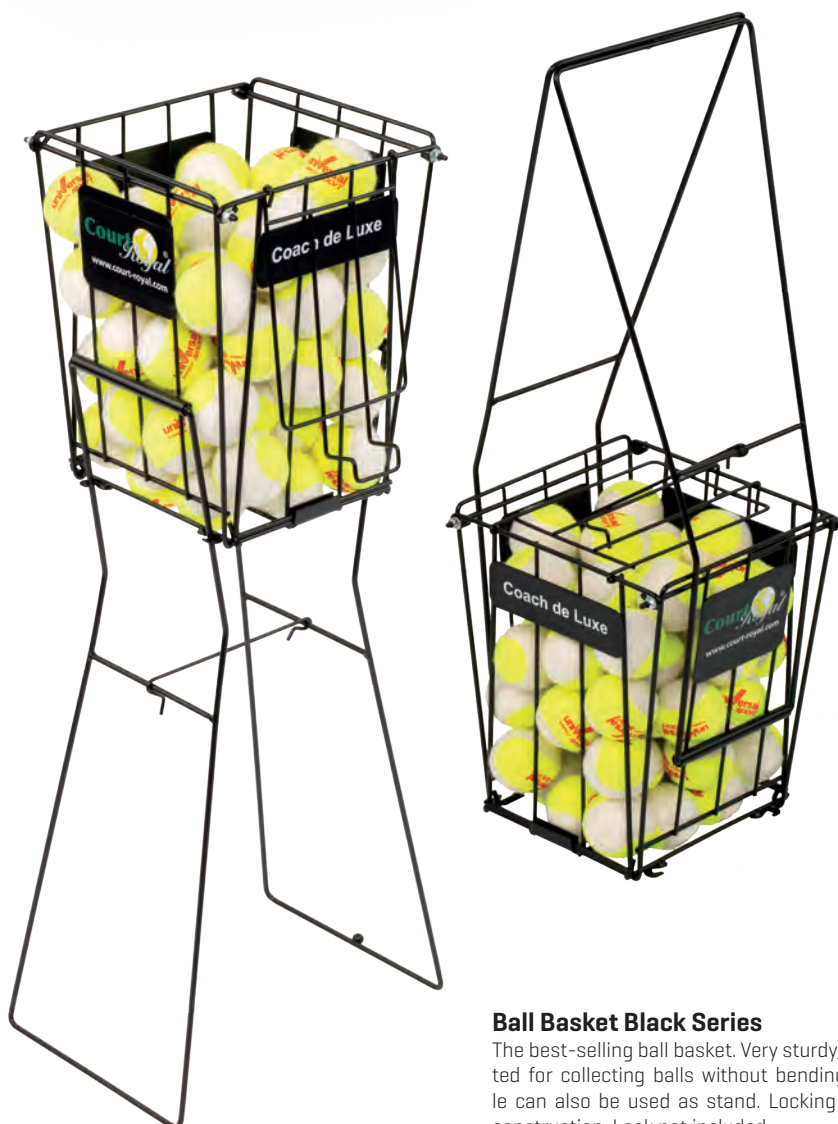

### Ball Basket Black Series

The best-selling ball basket. Very sturdy, chrome-plated for collecting balls without bending over. Handle can also be used as stand. Locking cover, sturdy construction. Lock not included.  
Capacity: 70 balls.  
No. 42080



### Ball Pickup Tube Court Royal

Saves time and efforts picking up balls. Simply press this practical tube down onto the balls on the floor and it picks them up. Holds 17 balls. To empty the tube, just open the cover at the opposite end.  
Length 120 cm, Weight: 0.8 kg  
No. 42053



Extra sturdy edge reinforcement



### Ball Basket Court Royal Easy Pack Black Series

The new ball basket leaves nothing to be desired. The ball basket Easy Pack with detachable bag for 120 balls can be easily folded and stored in a small space. The mobile rack is made of aluminum.  
No. 42054



### Ball Trolley Court Royal Black Series

Very stable trolley, easily moveable thanks to large pulleys. Big ball basket and extra storage tray. The poles, baskets and the lockable lid, without lock, are black powder-coated.  
Capacity: 330 balls, Size: [L x W x H] 60 x 49 x 92 cm, Cage Size: [L x W x H] 60 x 49 x 36 cm, Weight: 10 kg.  
No. 43021

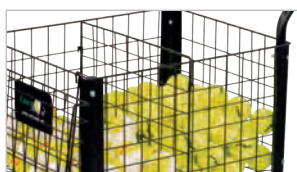

### Separating Grid For Ball Trolley Court Royal

With the separating grid you can separate two different ball types.  
No. 430215



### JOWO Tennis Caddy Black Series

The ideal partner for professional tennis trainers. Three height adjustment settings, simple and fast handling in transport. Can be folded for storage in a small space. Lockable cover. Sturdy, weatherproof structure. Capacity: 220 balls.  
No. 42087





**Tennisball Balls Unlimited Code black**

A combination of natural rubber and woven English Playnes felt. In our range of products this excellent tournament ball guarantees maximum performance and stability. Clearly less expensive than comparable brands. ITF approved tournament quality.

No. 46014 pack of 4

**Tennisball Balls Unlimited Code Red**

A combination of natural rubber and woven TTI-felt. This tournament ball guarantees maximum performance and stability. A superb playing behavior and an excellent price/quality-ratio. ITF approved tournament quality.

No. 42093 pack of 4



**Tennisball Court Royal Coach**

High-quality woven needle felt, perfect price/quality ratio, popular with trainers, excellent stability. Suited for ball machines.

No. 42091 yellow

pack of 60



**Universal Sport Coach**

High-quality woven English TTI-felt. Pressureless tennisball in tournament quality. The long-lasting elasticity of the pressureless core guarantees extremely long stability. Especially suited for ball machines.

No. 42094 yellow/white

pack of 60



**Universal Sport Coach**

High-quality woven English TTI-felt. Pressureless tennisball in tournament quality. The long-lasting elasticity of the pressureless core guarantees extremely long stability. Especially suited for ball machines.

No. 42090 yellow

pack of 60





### Marking Markers

Ideal for marking in training. Soft hemisphere with 20 cm Ø in 4 different colors, height 9 cm, 40 pieces stacked on a carrier pole.  
No. 20351



### Hurdles Set

6 hurdles, adjustable in height to 20 cm and 33 cm. Width 44 cm, complete with bag.  
No. 21560

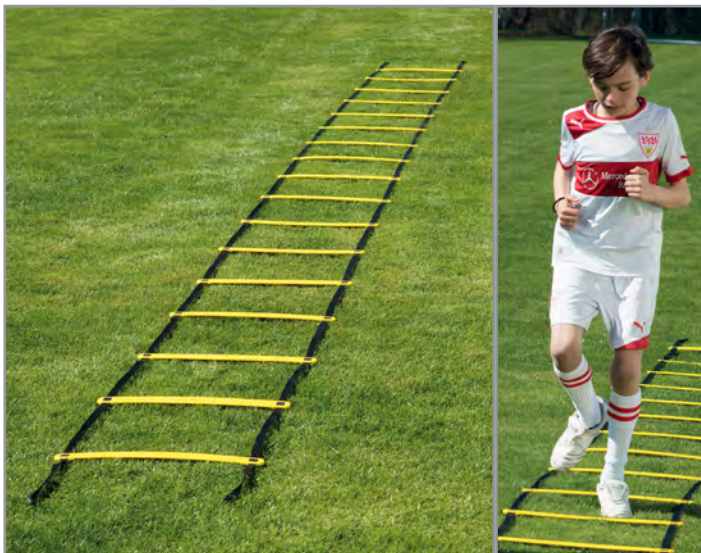

### Coordination Ladder

Very good coordination and fitness training, due to flat strips fixed to a fabric band making injury almost impossible, suitable for many surfaces, robust quality. Dimensions: 800 cm long, 50 cm wide, 45 cm distance between strips, complete with bag.  
No. 42045



### Marking Plates

Made of soft PVC, diameter 19 cm, height, 50 plates in 5 different colors, per color 10 pieces  
No. 20454 Packaging unit 50 plates



### 1) Marking Cone 40

Plastic, 40 cm high, for multiple use.  
No. 20392 red, No. 20393 yellow, No. 20395 green, No. 20396 blue

### 2) Marking Cone 28

Plastic, 28 cm high  
No. 20373 red, No. 20374 yellow, No. 20375 green, No. 20376 blue

### 3) Marking Cone 24

Red plastic, 24 cm high.  
No. 20377

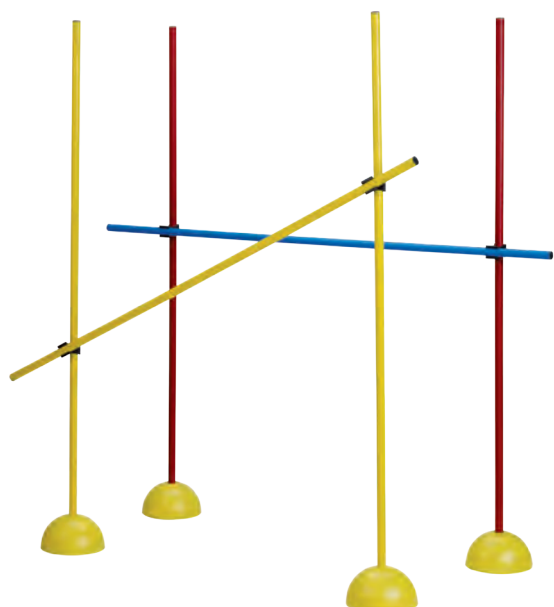

### Training Aid

The exercise/training aid for all types of sports is a complete training system with countless potential applications; from tennis, football, track and field, handball, basketball right through to motor sports. There are no limits to the imagination of trainers and athletes. The exercise aid can be used for school sports, basic training, right through to professional sports. Base can be filled with sand or other dry materials. Poles are made of high-grade elastic plastic. They can be inserted into the base or used as crossbars. The newly developed plastic clip can be set to any position. The poles can be positioned loosely or clipped onto other poles.

Complete set consists of:  
2 bases, 3 poles 160 cm long, 2 solid plastic clips  
No. 20315 1 set  
No. 20316 5 sets

### Foot Plastic half bowls

No. 20317

### Plastic Pole 160 cm long

No. 20318





### Medicine Balls

Made of rubber with non-slip surface and needle valve.

- No. 22023 1000 g
- No. 22025 2000 g
- No. 22026 3000 g
- No. 22027 4000 g
- No. 22028 5000 g



### Jump Rope

Colored plastic rope with sturdy handle.

- No. 565 red 230 cm
- No. 567 yellow 240 cm
- No. 568 green 250 cm
- No. 569 blue 260 cm



### Fun Bal

The fun ball bounces in all directions. Ideal for reaction-training.

- No. 420951 7 cm



### Special ball for ball feeling and technique

The new elasticated balloon cover is ideal for tennis technique training. Thanks to the slower flight characteristics, children have enough time for a clean stroke technique with the tennis racket. The set consists of two balloons and a high-quality cover. With a diameter of 25 cm, this is the perfect size.  
No. 42055



### Fitness dumbbell 2 kg

Hexagonal fist dumbbell covered with colored vinyl. Comfortable in the hand and gentle on the ground. Easy to clean.

- No. 702301

## Kid's Tennis





**Tennisball**  
**Balls Unlimited Stage 1**  
High-quality woven flex felt. 25% slower and 10% lighter than normal tennisballs. ITF approved.  
No. 45080 pack of 12



**Tennisball**  
**Balls Unlimited Stage 2**  
High-quality woven flex felt. 40% slower and 20% lighter than normal tennisballs. ITF approved.  
No. 45081 pack of 12



**Tennisball**  
**BIMBI Easy Stage 2**  
High-quality woven flex felt. 40% slower and 20% lighter than normal tennisballs. Applied over years in smallfield-tennis-championships, ITF approved. Weight: approx. 43g. An absolute premium product.  
No. 460020 pack of 12



**Tennisball**  
**Balls Unlimited Stage 3**  
High-quality woven flex felt. 6% larger and 20% lighter than normal tennisballs. ITF approved.  
No. 45082 pack of 12



**Foam Ball Stage 3**  
Soft foam ball especially developed for starting off on the small field and midcourt. Distinctly larger than Stage 1 + 2 balls, slower bounce and flight behavior.  
No. 42096 pack of 12

The colours of the tennis rackets are not binding.



**Stage 1 Children's Racket**  
The perfect racket for children aged between 8 and 12 years! For full court, length: 64 cm, weight: 220 g.  
No. 45075



**Stage 2 Children's Racket**  
The perfect racket for children aged between 7 and 11 years! For mid court, length: 60 cm, weight: 200 g.  
No. 45073



**Stage 3 Children's Racket**  
The perfect racket for children aged between 5 and 8 years. For mini court, length: 54 cm, weight: 180 g.  
No. 45072



**Stage 4 Children's Racket**  
The perfect racket for children aged between 3 and 5 years. For mini court, length: 48 cm, weight: 170 g.  
No. 45071



**Stage 5 Children's Racket**  
The perfect racket for children aged under 3. For mini court, length: 43 cm, weight: 150 g.  
No. 45074

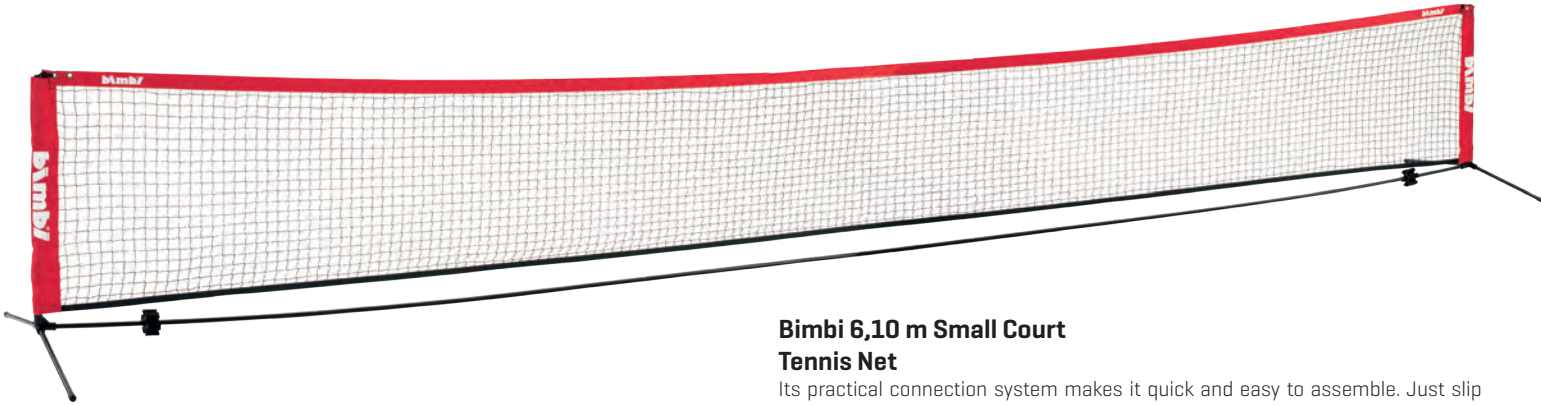

### Bimbi 6,10 m Small Court Tennis Net

Its practical connection system makes it quick and easy to assemble. Just slip the net over the two posts. 5 different net tension levels. Supplied with storage bag. Size: 6.10 x 0.85 m  
No. 40506

### Bimbi Replacement Net 6,10 m

No. 40509



### Bimbi 3 m Small Court Tennis Net

Its practical connection system makes it quick and easy to assemble. Just slip the net over the two posts. 5 different net tension levels. Supplied with storage bag. Size: 3 x 0.85 m  
No. 40500

### Bimbi Replacement Net 3 m

No. 40501

The colours of the tennis rackets are not binding.



### Bimbi Small Court Tennis Net, 3 m Street Set

Just like the Bimbi 3m Small Court Tennis Net, but with 2 Topspin 60 cm tennis rackets and 6 Bimbi Easy balls.  
No. 40512



### Bimbi Small Court Tennis Net, 6.10 m School Set

Just like the Bimbi Small Court Tennis Net 6.10 m but with 4 Topspin 60 cm tennis rackets and 12 Bimbi Easy balls.  
No. 40510

The Universe of Sports

## Bimbi Small Court Tennis System

This practical system was used in the small court tennis project run by the German Tennis Association and has proved its value. Fast and simple to assemble. Stable when assembled because of its wide stands. Ideal net tension with self-tensioning system. Can be stored in a small space in a practical bag. Official German Tennis Association size: 6.10 x 0.85 m. Weight approx. 6.5 kg. No. 40488

## Replacement net 610

No. 40489

## Bag

No. 40503

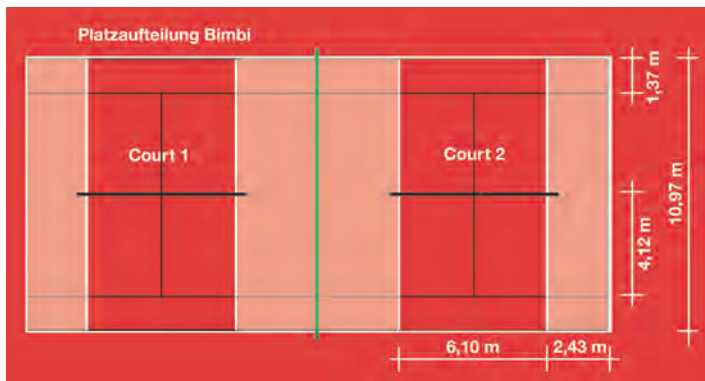

## Marking trolley for Tennis

New product developed for children's tennis, spreading width approx. 50 mm. No. 45005

## Chalk for Tennis Courts

5 kg. in pail No. 45009





## Bimbi Club Package II

Consists of: 1 Bimbi small court tennis system, 4 Bimbi children's rackets and 1 Bimbi Easy-Set.  
No. 46033



The colours of the tennis rackets are not binding.

## Bimbi School Tennis Package II

Consists of: 2 Bimbi small court tennis systems, 16 Bimbi children's rackets and 2 Bimbi Easy-Sets.  
No. 46031



### Circle Marking Tape

Made of high quality PVC, can be used on all surfaces. Set of 4, green.  
No. 43018

### Line Marking Tape

Made of high quality PVC, can be used on all surfaces. Set of 10, green.  
No. 46041

### Corner Marking Tape

Made of high quality PVC, can be used on all surfaces. Set of 4, green.  
No. 43016



The Universe of Sports

## Children's Net System

Sturdy aluminum system, 40 x 40 mm tubes. Easy to dismantle and to transport. Consists of 2 aluminum bases including posts, each 3.05 m long, 2 net holding rods and a nylon net. Dimensions 6.10 m x 0.85 m. No. 40491

## Children's Net System mobile

Like article No. 40491 but with 6 rollers. No. 40493

## Children's Net Nylon

6.10 x 0.85 m  
No. 40564



## Marking Lines for Kid's Tennis

Marking lines for small court tennis. Made of heavy-duty, non-slip and indestructible PVC. The weight of the line keeps it flat on the ground and it needs no additional fixation. Marking set of 2 rolls, 11 m long, 8 cm width. No. 45000 white

## Youth Stage 2

Rubber lines for the original Stage 2 court. 2 side lines: 3 cm, 2 base lines 4 cm wide. Color white. Excellent UV resistance. Supplied with fixing nails and assembly instructions. Original length: 17.83 x 6.17 [single] or 8.23 m [double]. No. 45001

## Youth Stage 3

Rubber lines for at least 2 original Stage 3 courts. 4 lines, 6.60 m each (can be extended to 11 m) color white. Excellent UV resistance. Supplied with fixing nails and assembly instructions. Includes tennis court lines. No. 45002

# Ball Sports + Equipment





### Volleyball Post Heavy Duty

Absolutely weatherproof, very sturdy, vandalism-proof, competition-approved volleyball post made of 90 x 90 x 4 mm hot-dip galvanized steel profile. Height adjusted with a very easy-to-handle mechanism. Net tensioned with a turnbuckle. Complete with ground sleeves 35 cm. Post length 300 cm.  
**No. 30510**

### Volleyball Post Universal 80 Aluminum

Reliable, solid volleyball post 80 x 80 mm aluminum, compliant with DIN 7896. Easy-running net attachment and tensioning devices (galvanized, trapezoid thread mechanism) continuously adjustable. Surface of the posts and impulse profiles are matt-silver anodized. Complete with ground sleeves and covers.  
**No. 30500**

### Volleyball Post Universal 83 Aluminum

Reliable, solid volleyball post 83 mm made of aluminum special profile, compliant with DIN 78966. Easy-running net attachment and tensioning devices continuously adjustable. All steel parts are galvanized. Post surface is matt-silver anodized. Complete with ground sleeves and covers.  
**No. 30501**

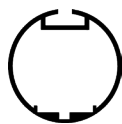
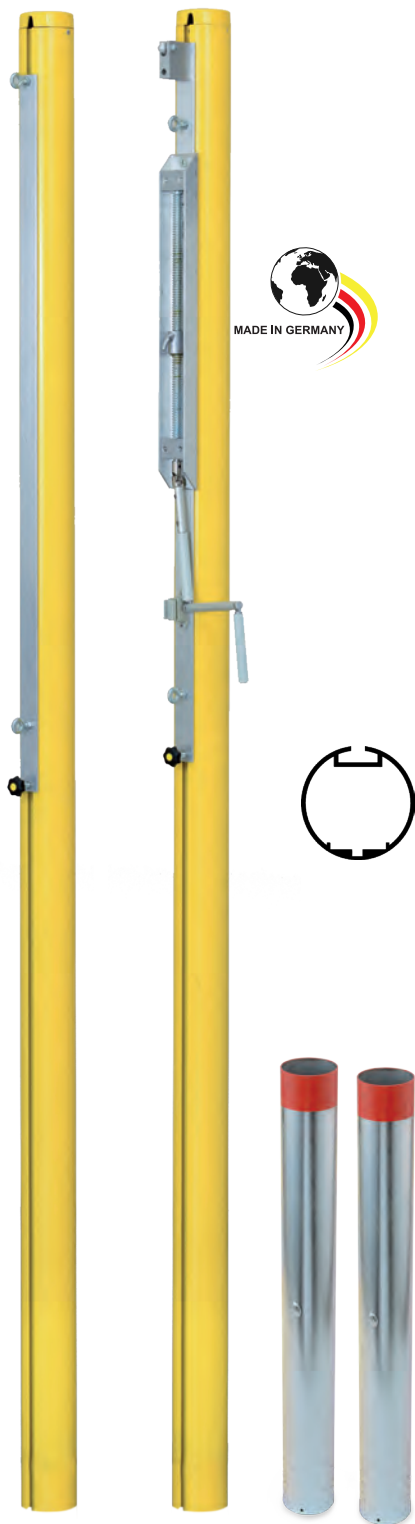

### Beach Volleyball Post Court Royal 83

83 mm Ø aluminum (DIN 7896). Easy running net attachment and tensioning devices (galvanized, trapezoid thread mechanism) steplessly adjustable. Surface is yellow powder-coated.

**Delivery without ground sleeves**  
No. 30693

### Ground sleeves

Made of hot-dip galvanized steel for installation in sand fields, length 70 cm  
No. 30694



### Volleyball Referee Tower

Umpire chair made of aluminum special profile Ø 35 mm, height-adjustable, 3 adjustment options, complete with 4 rubber pads, 2 lashing straps and writing board.  
No. 30600



### Volleyball Referee Tower Professional

Solid steel construction, painted black, height-adjustable, wooden platform. Ladder entry from the back. Two transport wheels for the easy transport of the umpire chair. Used at numerous volleyball tournaments.  
No. 30603



### Beach Volleyball Marking Lines

9 x 18 m, made of polyester tape 50 mm, with loops at each corner and middle marking. Complies with the GVF [German Volleyball Federation] requirements. Wounded onto a plastic roll. Complete with 4 ground anchors. Color, dark blue.  
No. 30688

### Beach Volleyball Marking Lines Turnier

9 x 18 m (or 8 x 16 m) with adjustable plastic corner elements, 50 mm wide PES-webbing and middle marking. Complete with 4 plastic ground anchors, 23 cm long and bungee tensioning ropes. color: dark blue.  
No. 30686





### Badminton Umpire Chair

Elegant aluminum badminton umpire chair with European Seal of Approval DIN EN 131. Very robust because of the stable ladder and the projecting supports with four base plates. The seat mount has an extra crossbar behind the UV-resistant body-contoured seat. Including writing-board.  
No. 30888



### Badminton Post Court Royal

protecting rubber buffers on the support part. Game columns made of 80 x 80 mm special aluminum profile. Including tension belt and slidable eyebolt slide for unclamping the net. Steel parts painted blue, aluminum parts silver anodised. Weight 80 kg, width ca. 86 cm, projection 70 cm.  
No. 30828



### Badminton Post I

For competitions and school sports. Post made of 50 x 50 mm aluminum profiles. Complete with hooks, tensioning belt and ground sleeves.  
No. 30802



### Badminton Post II

For competitions and school sports. Posts made of ø 83 mm aluminum special profile. Complete with hooks, tensioning belt and ground sleeves.  
No. 300802



### Badminton Post Hobby

Movable free-standing system with rubber wheels on the weighted base. Posts made of 40 x 40 mm steel pipe. Complete with hooks and tensioning belt, painted blue. Weight per post approx. 25 kg, radius 60 cm  
No. 30803



### Universal Posts Cort Royal freestanding

Can be used outdoors as well as in the hall. The multi-game system developed by Universal Sport is suitable for all net and line games. Due to the easy-to-read scale with game markers, a height adjustment is easily possible, even if the net is stretched. The system consists of two base frames weighing 118 kg each. Ball-bearing solid rubber-wheels allow easy transport with set weights. The system is equipped with bottom-protecting rubber points on the underside. The 80 x 80 mm steel columns are infinitely adjustable from 1,00 - 2,45 m and equipped with a safety lock. An all-purpose net (length 6,10 m) is included. The following types of game are possible: tennis, - children's tennis - fistball - volleyball - beachvolleyball - football tennis - bouncing ball - Indica - ring tennis - badminton.

No. 32001



### Additional Weight for tournament use

Steel weight with handle, blue painted. Including bolts for attaching to universal posts Cort Royal.

Weight 38 kg  
No. 30848

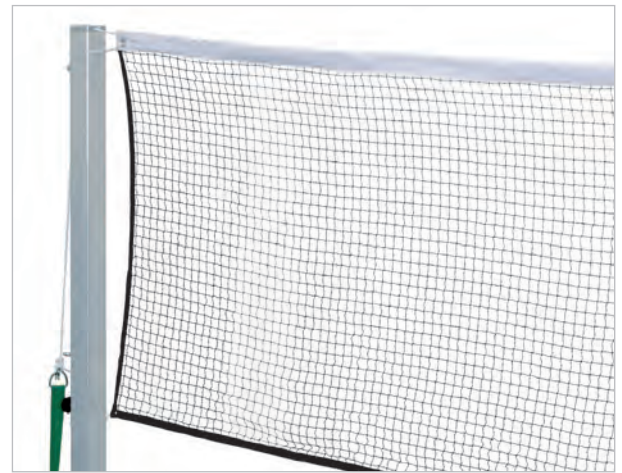

### Badminton Net Training

Made of 1 mm nylon cord, with tensioning cord. Size 6.10 m wide, 76 cm high. Mesh size 18 mm, edged all round.

No. 30840

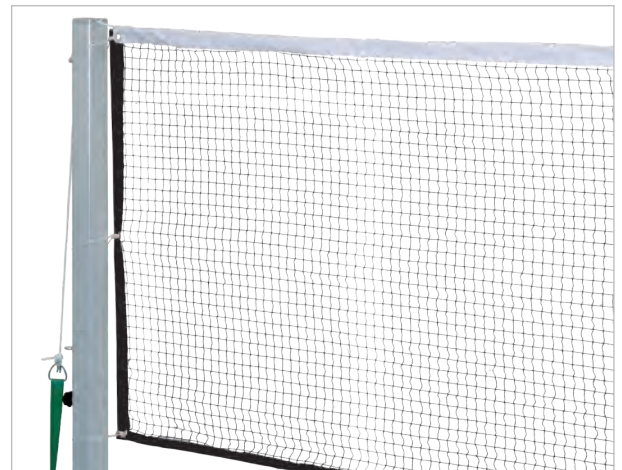

### Badminton Net Olympia

Made of 1.2 mm nylon line with tensioning steel wire, 6.60 m long. Size 6.02 m wide, 76 cm high, mesh size 18 mm, edged all round.

No. 30860

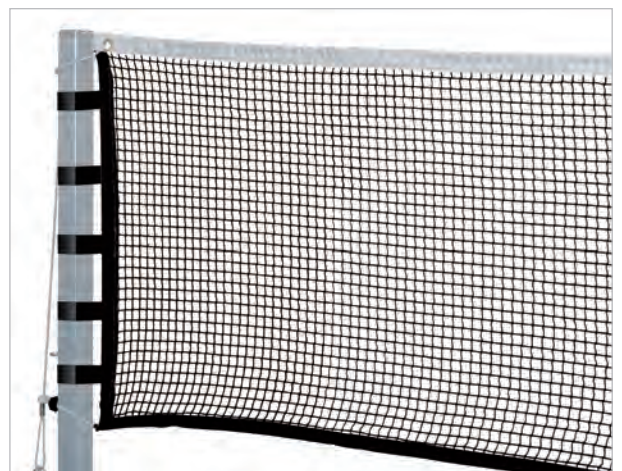

### Badminton Net Court Royal Super Cup

Made of 1.2 mm black nylon cord. Size 6.02 m wide, 76 cm high, mesh size 20 mm. With PES framing on top, 75 mm, with twisted PE rope 8,0 m. Both sides and bottom bordered with 30 mm black PES lateral framing. On both sides there are 5 velcro fasteners to attach the net to the posts.

No. 30850

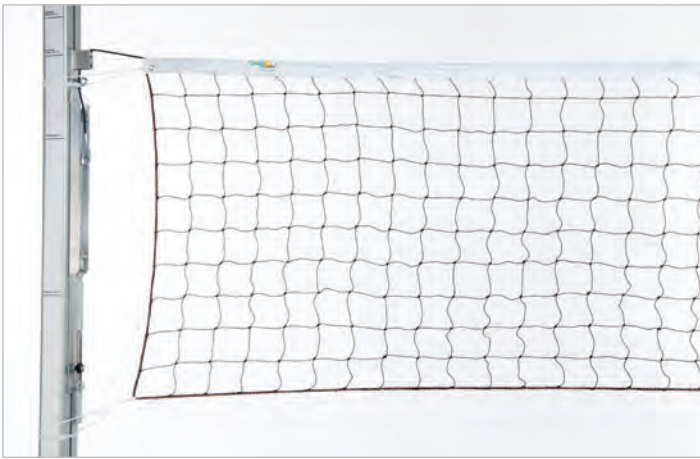

### Volleyball Net Court Royal Training 2 mm

Black polyethylene net 2 mm, with 100 mm wide edging on top in white, and 5 mm coated steel cable 11, 7 m. Mesh size 100 mm. Dimensions: 9,5 m x 1 m  
No. 30620



### Volleyball Net Court Royal Competition 3 mm

Black polyethylene net 3 mm, with 100 mm wide edging on top in white, and 5 mm coated steel cable 11, 7 m. Mesh size 100 mm. Dimensions: 9,5 m x 1 m  
No. 30660



### Beach Volleyball Net Court Royal 2 mm

Black polyethylene net 2 mm, 9,5 m long, 1 m high, with 50 mm wide coated edging in green. Mesh size 100 mm. Dimensions: 8,5 m x 1 m  
No. 30684



### Beach Volleyball Net Competition Net

Top 3 mm, low-stretch polyester tensioning rope, bottom 4 mm tensioning rope. With 4 tensioning cords as well as 75 mm wide coated edging in neon yellow. Mesh size 100 mm. Dimensions: 9,5 m x 1 m  
No. 30681



### Volleyball Antenna one piece

With GVF certification mark, length 180 cm, complete with bag and marking tape.  
No. 30675





## Mini playing field Arena Court Royal stationary

This facility fulfils the requirements of a modern sports facility that is designed for long-term use. Support posts made of aluminium profiles are set in concrete at 5 metre intervals, between which steel-coated composite elements are mounted vibration-free. The elements of the pitch boards are extremely robust, weather-proof, impact-resistant, physiologically harmless and at the same time quiet.



Prices, technical details, other playing field variants and accessories on request



## Court Royal Street Soccer mobil

The weatherproof board system in 3 standard sizes can be assembled and dismantled as often as required, transported and stored to save space. Assembly and dismantling is particularly quick and easy without tools. It is intended for temporary use, e.g. for events, celebrations, trade fairs, etc.. The white advertising spaces are ideal for displaying sponsor advertising. We will be happy to make suggestions for the foiling of the hard foam panels. Special sizes and other designs on request.



## Arena Court Royal stationary

No. 208010 20 x 13 m - 2 goals 3 x 2 m

**Court Royal Arena stationär** With protective net on front and long side

No. 208011 20 x 13 m - 2 goals 3 x 2 m

## Arena Court Royal stationary

No. 208012 30 x 15 m - 2 goals 4 x 2 m

**Arena Court Royal stationary** With protective net on front and long side

No. 208013 30 x 15 m - 2 goals 4 x 2 m

## Arena Court Royal stationary

No. 208015 40 x 20 m - 2 goals 4 x 2 m

**Arena Court Royal stationary** With protective net on front and long side

No. 208016 40 x 20 m - 2 goals 4 x 2 m

### Technical Details:

- Support posts set in concrete at 5 m intervals, to which composite elements in sandwich construction are mounted (element dimensions: 5 x 1 m x 4 cm)
- Sturdy, fully welded football goals made of aluminium oval profile with large net hoop construction and access door (goal dimensions: 4 x 2 m and 3 x 2 m)
- Optionally with front and long-sided net construction, 3 m total height
- Can be extended with volleyball or basketball facility
- The entire construction is GS-tested



Optional equipment for other ball sports

## Court Royal Arena Street Soccer small

11 x 6 m / Tore 1,8 x 1,2 m (0,7 m deep)

No. 208017

No. 208018 With surrounding net

## Court Royal Arena Street Soccer medium

15 x 10 m / goals 1,8 x 1,2 m (0,7 m deep)

No. 208019

No. 208020 With surrounding net

## Court Royal Arena Street Soccer big

20 x 13 m / 2 goals 3 x 2 m (1 m deep)

No. 208021

No. 208022 With surrounding net

### Technical details and basic equipment:

- Mobile and flexible board system for temporary limited use
- Quick assembly and dismantling
- Simple hook-in and Velcro system, without screw connections
- Safety-tested design in accordance with DIN EN 15312 With certificate: robust, weatherproof, low-noise
- Closed all-round railing system, approx. 90 cm high, approx. 2.5 cm thick
- Boards made from plastic-coated hard foam board
- Basic construction made from corrosion-free aluminium
- Fully welded mini football goals, integrated into the board system
- Boards are ideal as advertising space



### Youth Soccer Goal Court Royal 3 x 2 m, completely welded, in 4 parts

The newly developed Youth Soccer Goals Court Royal are delivered in four parts. Their stability comply with the fully-welded aluminum-goals. The fully-welded side frames are joined by 102 mm long round profile bars which are fitted with very sturdy interior profiles to join the parts together. Goalposts and bars are made of aluminum. The warp-resistant profile is fitted with a particularly deep groove, in which the plastic net-holders are inserted. According to regulations a tilt-resistant ground anchoring for grassy fields is included. Alternatively anti-tilt weights for synthetic fields are available. The goal meets the FIFA and DFB standards and is produced according to DIN EN 748.

Dimensions: 3 x 2 m, Depth at base: 1,25 m

No. 202022

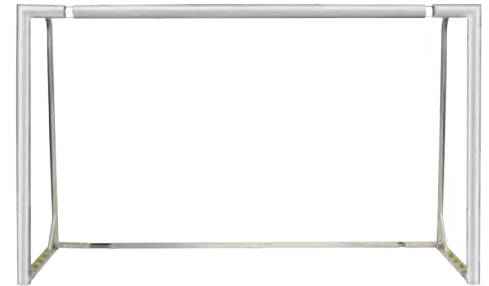

### Youth Soccer Goal Court Royal, fully welded, in four parts

The newly developed free-standing Youth Soccer Goals Court Royal are made of plain aluminum and are delivered in four parts and comply with its stability with the fully-welded aluminum goals. The goal frames and base frames are of 120 x 100 mm oval profiles. The two side elements are fully-welded and are connected with the cross bar by super stable interior profiles.

The torsion-free special profile is fitted with a groove in which the provided plastic net holders can be inserted. For additional charge of 7 % the goals can be delivered with an integrated net holder. According to regulations an ant-tilt-resistant ground anchoring for grassy fields is included.

Alternatively an anti-tilt-resistant ground anchoring for hard courts is available as well. The goals comply with the FIFA and DFB standards, are produced according to DIN EN 748 and are safety tested [ GS-tested ]. Dimensions: 5 x 2m

No. 202021 1,5 m width

### Youth Soccer Goal Net Borussia

Very sturdy net made of high-strength 4 mm polypropylene.

No. 20240 green

No. 20241 white





### Handball Goal Court Royal

According to safety standard DIN-EN 749, goal frame 3 x 2 m welded, standard goal depth 1.25 m (optional 1.45 m). Made of especially thick-walled 80 x 80 mm aluminum profile with rounded edges, base pipe for screwing in, very sturdy rear construction, base frame made of 75 x 50 mm square aluminum profile with guide groove, net hoop made of 50 x 3 mm round pipe for free net suspension (the net is not pulled over the hoops).

No. 20520

### Small Field and Handball Goal Net

High-strength 4 mm polypropylene

No. 20610 white

No. 20611 green

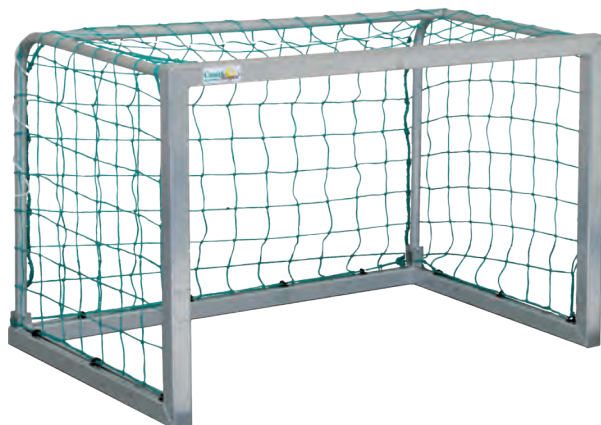

### MINI Aluminum Training Goal

120 x 80 cm, 80 cm deep. Hinged net brackets, with floor tube. Complete with net made from high-strength 3 mm polypropylene. 10 cm mesh width.

No. 202081 adjustable

No. 2020811 fully-welded

### Replacement Goal Net

No. 202082 mesh width 10 cm

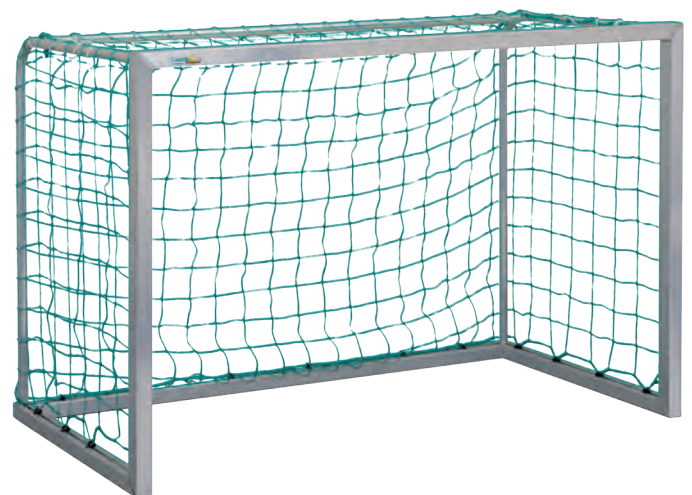

### MAXI Aluminum Training Goal

180 x 120 cm, 80 cm deep. Hinged net brackets, with floor tube. Complete with net made from high-strength 3 mm polypropylene. 10 cm mesh width.

No. 202091 adjustable

No. 2020911 fully-welded

### Replacement Goal Net

No. 202092 mesh width 10 cm





### Streetball Unit Court Royal with Grid Backboard

Stable single-post structure made from 90 x 90 mm steel tube, hot-dip galvanized with screw-on plate for basket. Grid backboard 120 x 90 cm, including super-stable basket ring with chain net, galvanized, including ground sleeve.

No. 300262 extension 120 cm  
No. 300222 extension 165 cm



### Streetball Unit Court Royal Heavy Duty with Aluminum Backboard

Stable single-post structure made from 90 x 90 mm steel tube, hot-dip galvanized with screw-on plate for basket. Including target backboard made from 8 mm solid aluminum 120 x 90 cm, painted white. Including super-stable basket ring with chain net, galvanized, including ground sleeve.

No. 300232 extension 120 cm



### Streetball Unit Court Royal Heavy Duty with Grid Backboard

All-metal competition streetball system made of galvanized steel pipe 114 x 4.5 mm. Steel grid board, extra low-noise, hot-dip galvanized, 120 x 90 cm. Powder-coated with flat iron enhancement for fixing. DIN drill-holes, with chain net.

No. 300230 extension 120 cm



### Basketball System Court Royal with GFK Backboard round

Stable single-post structure made from 90 x 90 x 4 mm steel tube, hot-galvanized, fully welded with screw-on plate for basket. Ground sleeves are hot-galvanized with anti-lift device. GS approved, produced according to DIN EN 1270. Made in Germany. GFK board in rounded shape 120 x 90 cm with an orange-coloured DIN-basket and a 6 mm nylon net, including ground sleeves.

No. 30026 extension 120 cm  
No. 300220 extension 165 cm



### Basketball System Court Royal with Aluminum Board 120 x 90 cm

Stable single-post structure made from 90 x 90 x 4 mm steel tube, hot-galvanized, fully welded with screw-on plate for basket. Ground sleeves are hot-galvanized with anti-lift device. GS approved, produced according to DIN EN 1270. Made in Germany. A massive 8 mm strong aluminum board, angular form 120 x 90 cm with Big Duty basket and a chain net which is attached at 12 points, including ground sleeves.

No. 30022 extension 120 cm  
No. 300264 extension 165 cm



MADE IN GERMANY



### Stabilizing bracket for basketball board

Additionally for all basketball boards. Provides an even better stabilization of the board and reduces oscillations and vibrations.

No. 300269



## Big Duty Basketball System

Steel tube single-pole frame made from square profile 15 x 15 cm, hot-dip galvanized, projection 165 cm, fully-welded. Including target backboard made from 8 mm solid aluminum 120 x 90 cm, painted white. Including super-stable basket ring with chain net, galvanized. Basket is screwed directly to frame and therefore prevents target backboard from being damaged if subjected to extreme stress. The system is extremely stable, weather-resistant, maintenance-free and vandalism-proof, therefore ideal for use on public playgrounds and sports facilities, galvanized. Basket is screwed directly to frame and therefore prevents target backboard from being damaged if subjected to extreme stress.

No. 30027 with Alu backboard 120 x 90 cm square

No. 30038 with Alu backboard round 120 x 90 cm



## Basketball Basket DIN red

According to international standard. Red powder-coated, complete with back plate with DIN drill holes 11 x 9 cm. Without net.

No. 300229

## Basketball Net Ultra

Nylon cord 6 mm.

No. 30230 white



## Basketball Basket Ultra Flex 70

Match basket according to international regulations. (DIN 1270) Double spring folding mechanism in closed safety housing. Inclination of the basket from 70 kg ring load. Red, powder coated with DIN drilling 11 x 9 cm. Without net.

No. 30227

## Basketball Basket Ultra Flex 30

Match basket according to international regulations. (DIN 1270) Double spring folding mechanism in closed safety housing. Inclination of the basket from 30 kg ring load. Red, powder coated with DIN drilling 11 x 9 cm. Without net.

No. 31040 [without illustration]



## Basketball Basket Big Duty

Indestructible basketball basket made of hot-dip galvanized steel. With DIN drill holes 11 x 9 cm. Without net.

No. 300219

## Chain Net

Galvanized steel.

No. 30233



### Streetball Backboard Fiberglass

ather resistant, anti-vibration Fiberglass Board. With black print on the side. Incl. DIN holes. Dimensions: 120 x 90 cm.  
No. 30212



### Streetball Backboard Alu

Made of 8 mm solid, fully welded aluminum. White powder coated. Incl. DIN holes. Dimensions: 120 x 90 cm.  
No. 30214

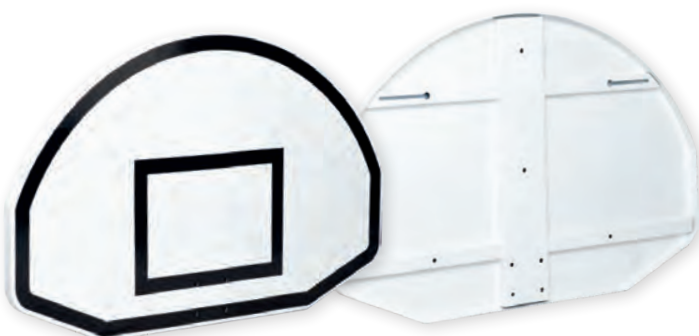

### Basketball Backboard Heavy Duty steel

White powder coated 4 mm thick steel board in Fan design. Absolutely weatherproof. Including DIN holes. Dimensions: 135 x 90 cm  
No. 300121

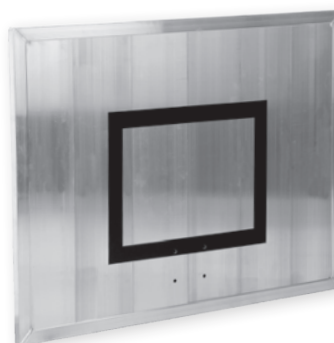

### Basketball Backboard Alu

Very stable anodized aluminum with reinforcement of the edges. Long-lasting and weather resistant. Perfect outdoor use. For highest demand. Vandalism-proof. Incl. DIN holes. Dimensions: 120 x 90 cm.  
No. 30216

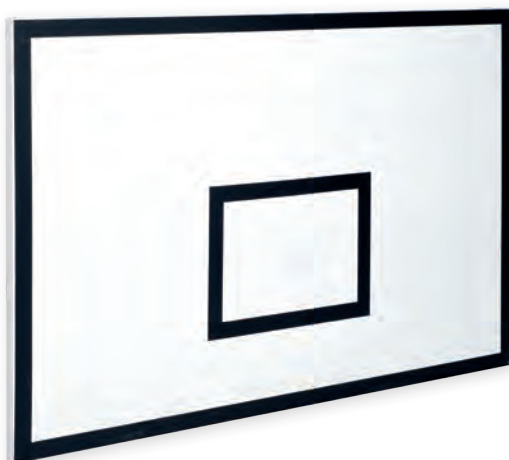

### Basketball Backboard Fiberglass

Absolutely weather resistant, anti-vibration Fiberglass Board without holes. Wooden core for individual attachment. Dimensions: 180 x 120 cm.  
No. 30200

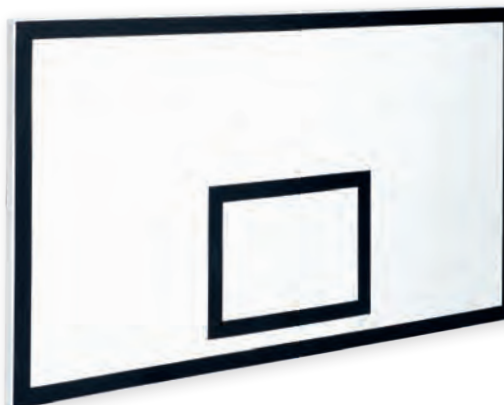

### Basketball Backboard Fiberglass

Absolutely weather resistant, anti-vibration Fiberglass Board without holes. Wooden core for individual attachment. Dimensions: 180 x 105 cm.  
No. 30201

### Streetball Grid Backboard

Made of fully welded grid. Low noise and wind permeable. Suitable for residential areas. Vandalism protected. Incl. DIN holes.

No. 300112 120 x 90 cm

No. 300115 180 x 105 mm

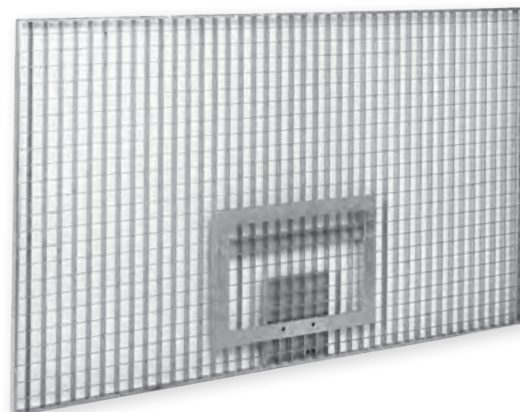
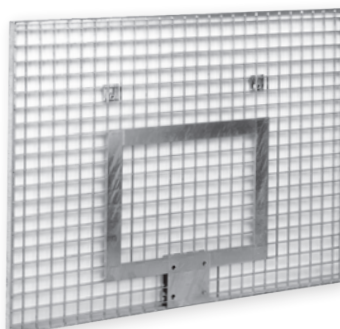



### Streetball Set Street

Weather-resistant plastic backboard 112 x 73 cm.  
Complete with basket and net.  
No. 310208



### Wall Mount

Wall fastening with approx. 30 cm extension.  
DIN drill holes 7.5 x 6.5 mm  
No. 300682

DIN drill holes 11 x 9 mm  
No. 300683



### Streetball Unit New York

Powder-coated steel post Ø approx. 95 mm to be set into concrete. Board 112 x 73 cm, basket Ø 45 cm and net. Height adjustable from 2.00 to 3.05 m. Extension 60 cm  
No. 31020

### Streetball Unit Atlanta

Free-standing, robust mobile system made from powder-coated steel tubing approx. 95 mm Ø. The base can be filled with sand [approx. 190 kg]. Weather-resistant, recyclable plastic backboard 112 x 73 cm complete with solid steel basket 45 cm Ø and nylon net. Basket height 3.05 m.  
No. 310201

### Streetball Unit Los Angeles

Free-standing, robust mobile system made from powder-coated steel tubing. The base can be filled with sand [approx. 190 kg]. The height of the basket can be automatically adjusted using a lever from 3.05 m [competition] to 2.10 m [kids]. Weather-resistant, recyclable plastic backboard 112 x 73 cm, complete with solid steel basket 45 cm Ø, nylon net and arm.  
No. 310203



**SCORLI  
LED-Anzeigetafel  
TENNIS**

## Scorli LED P5 Scoreboard for 9 sports

- 🔄 Tennis Table tennis Squash Badminton Padel Volleyball Beach volleyball Football Pickleball
- 🔄 A special application enables tablets and smartphones to the current score on the Scorli scoreboard in real time. real-time. Android + IOS
- 🔄 Match analysis
- 🔄 Sending of marketing messages
- 🔄 Automatic tournament management (in preparation)



Electronic scoreboard for indoor and outdoor use in real time. Scores and results are transmitted directly via Bluetooth from a tablet or smartphone [Android+IOS]. The electronic scoreboard's own operating system with SCOLI software and app enables interference-free data transmission with a range of up to 80 metres. Advertising and information can also be displayed from a smartphone, tablet or laptop via a Wi-Fi PC interface with optional Wi-Fi card and pre-installed app.

### Technical Details:

Resolution:	128 x 96 pixel
Display size:	640 mm x 480 mm [W x H]
Weight:	13 kg
Wi-Fi card:	(optional) TF-E6UW+hub75E005
Display:	Text and graphics
Readability:	70 m to 80 m during the day
Bluetooth:	Bluetooth 4.0 range up to 70 metres
<b>No 40896</b>	





## SCORLI LED P10 Large scoreboard for 9 sports

Electronic scoreboard for indoor and outdoor use in real time. Scores and results are transmitted directly via Bluetooth from a tablet or smartphone (Android+IOS).

The electronic scoreboard's own operating system with SCOLI software and app allows interference-free data transmission with a range of up to up to 100 metres.

Several display boards can be connected to each other.

Advertising and information can be additionally via a Wi-Fi PC interface with optional Wi-Fi card and pre-installed app from a smartphone, tablet or laptop.

No. 40898



### Technical Details:

Resolution:	128 x 96 pixel
Display size:	1280 mm x 960 mm [W x H]
Weight:	45 kg
Wi-Fi card:	[optional] TF-E6UW+hub75E005
Display:	Text, graphics and video
Readability:	100 m during the day
Bluetooth:	Bluetooth 4.0 range up to 70 metres
Power supply:	110 - 240 V



## Wi-Fi PC Card

The Wi-Fi PC card is plugged directly into the Scorli scoreboard and, together with a special application, enables advertising and marketing material to be sent via laptop / smartphone / tablet (Android + IOS).

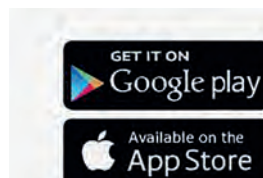



Illustration: Info box 41940 with title block incl. labelling



## Info-Box TMD 95

The information boxes in the TMD 95 series are absolutely weatherproof constructions suitable for outdoor and indoor use. They are made of high-quality, torsion-free aluminium profiles with a construction depth of 95 mm. The surface is silver matt anodised [E6-EV1].

### Basic housing

Very sturdy aluminium frame with recessed, corrosion-resistant coated steel rear panel.

### Front frame

The front frame consists of torsion-free multi-chamber aluminium profiles with an integrated, weather-resistant rubber seal and shatter-proof acrylic glass pane.

### Front frame stop without hinges

The special aluminium profiles that interlock across the entire width make it possible to dispense with hinges. This results in significantly greater stability.

### Special opening mechanism

The front frame opens upwards. It is held in the open position by automatically engaging catches. Lifting the front frame again releases the catches.

### Security lock

A high-quality safety lock is attached to the underside. This ensures trouble-free and simple operation. 2 keys included in the scope of delivery.

### Wall mounting

It is attached to the wall using two aluminium profile rails, which are installed on the wall side. The info box is hooked into the rails and fixed in place with 2 screws. All fastening parts are housed in the profiling of the frame. This means that it cannot be removed when closed and offers a high level of theft protection.

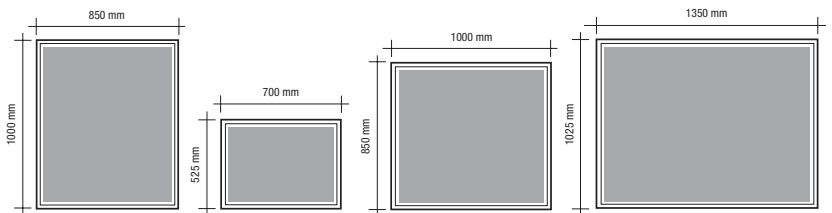

### Showcase TMD 95

Measuring: width x height x depth 95 mm Inner dimension: width x height x depth 80 mm incl. Magnets (Ø 30 mm) Weight	mm mm piece kg	700 x 525 640 x 465 10 12	1000 x 850 940 x 790 20 20	850 x 1000 790 x 940 20 20	1350 x 1025 1290 x 960 20 33
For outdoor and indoor use. Anodized (E 6-EV 1) aluminum housing with black magnetic board, safety lock with two keys and wall fixing set.	Art.-No.	41920	41930	41933	41940
<b>Accessories</b>					
<b>Lettering strip, neutral</b> Acryl glas 4 mm, translucent white H 120 mm	Art.-No.	47100	47101	47102	47103
<b>Lettering strip, with lettering</b> Version as above, but with choice of text (print letters)	Art.-No.	47110	47111	47112	47113
<b>Pair of stands</b> to set in concrete For free-standing installation. 2 aluminum square tubes 80 x 80 mm, height 2400 mm	Art.-No.	41948	41948	41948	41948
<b>Magnets</b> Ø 30 mm, 10 per set				Art.-No.	41929

## Badminton Court Dimensions

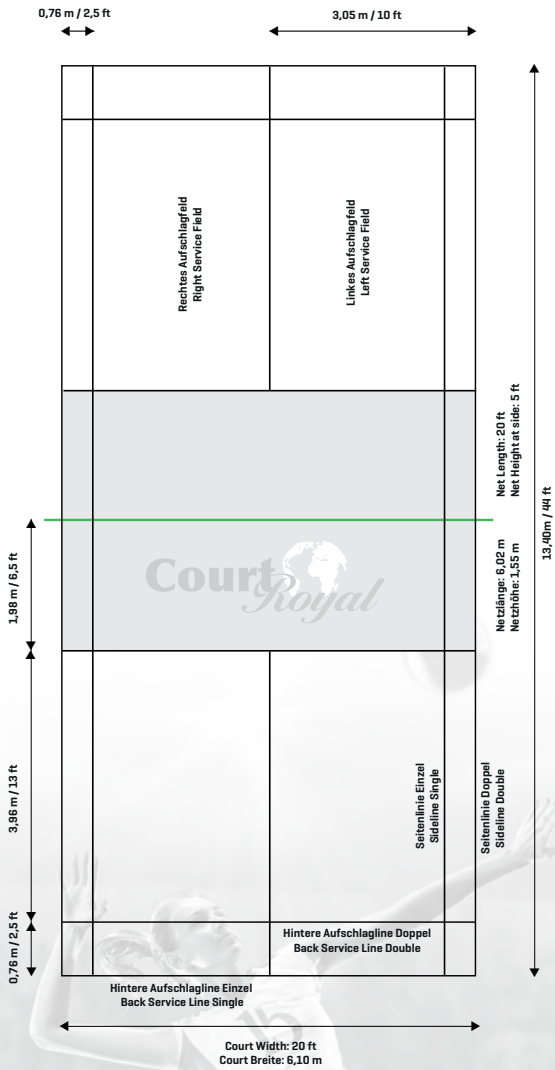

## Volleyball Court Dimensions

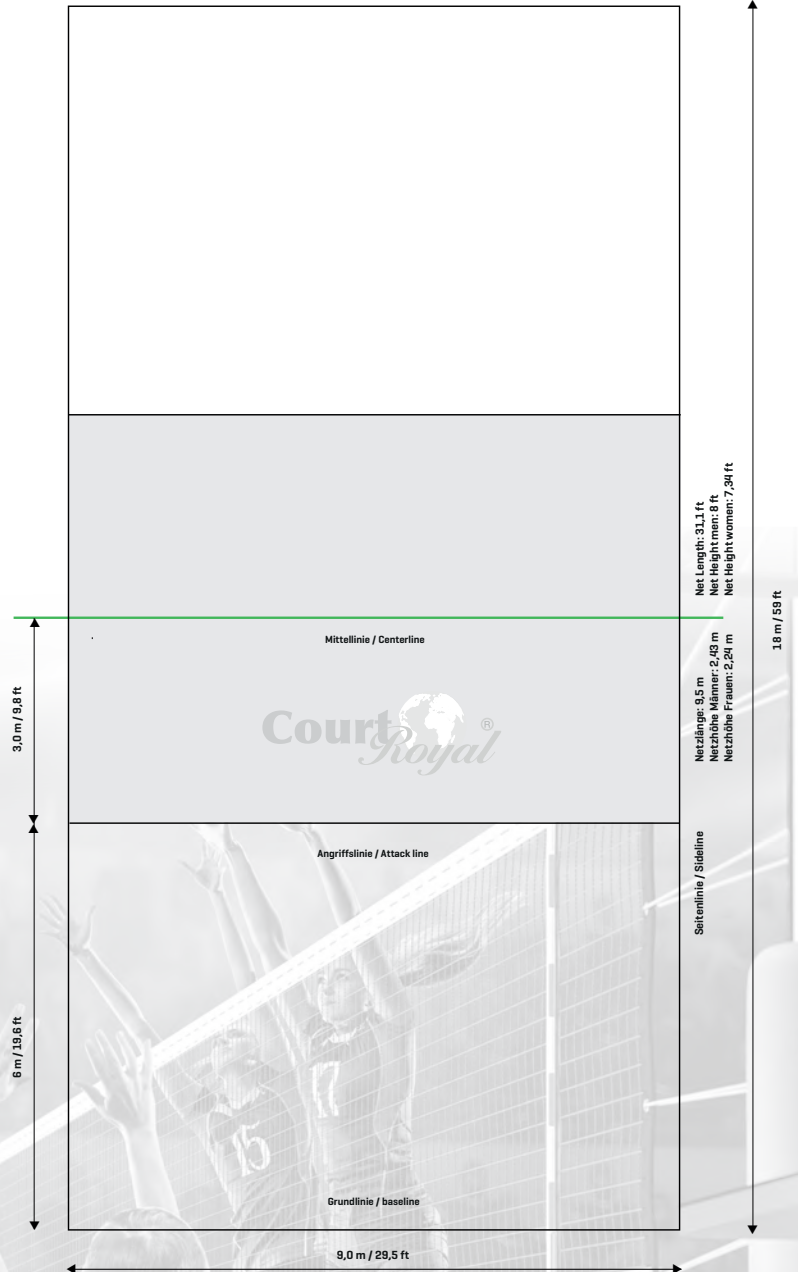

## Basketball Court Dimensions

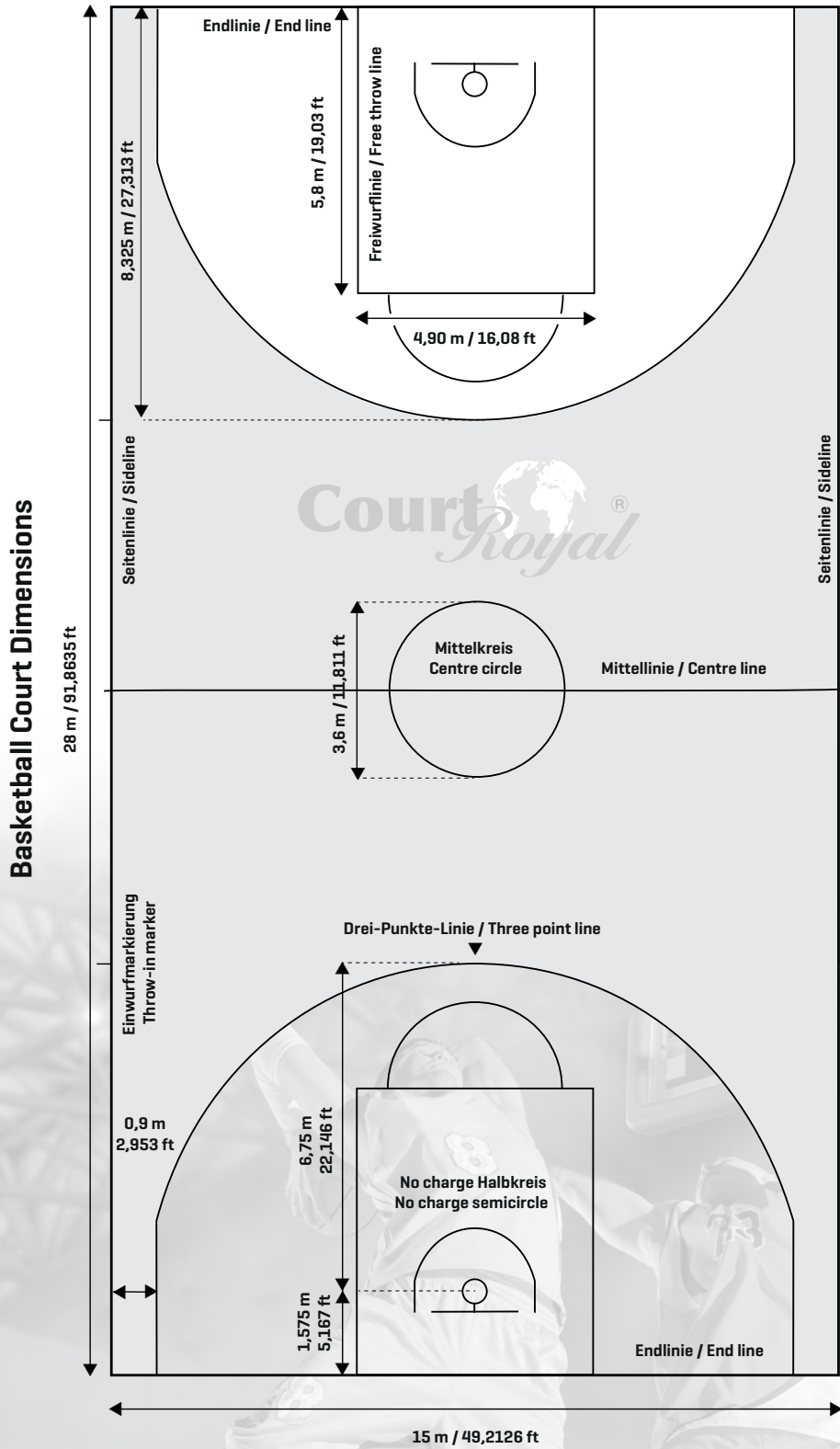

Copyright by Universal Sport GmbH 2024  
Maßangaben ohne Gewähr / Dimensions without guarantee

Die Abmessungen für Street Basketball finden Sie unter  
[www.universal-sport.com](http://www.universal-sport.com)

You can find the dimensions for Street Basketball at  
[www.universal-sport.com](http://www.universal-sport.com)



## Tennis net altimeter

Every tennis player should have this practical height gauge for tennis nets with them. Simply hang the tennis racket over the webbing in the centre of the net and let the chain with the solid steel ball hang on the ground.

When the ball lightly touches the ground, you have the prescribed net height of 91.4 cm. Galvanised version with storage bag.

No. 40562

**Court**  **Royal**<sup>®</sup>



## Tennis net posts

### Court Royal TP 80 // TP 83

Square 80 x 80 mm (TP 80) or round (TP 83) design. Special aluminium profile with internal reinforcement and groove for attaching the net holding bar. Internal trapezoidal tensioning mechanism with aluminium key for easy tensioning of the tennis net. Pluggable cast aluminium cover cap with safety chain. Total length of the posts 142 cm. Weight 10.5 kg.  
TP 80 No. 404461 square  
TP 83 No. 404471 round



### Aluminium bench seat with 4 seat shells Made in Germany

The brand new aluminium bench from our own production. Assemble the bench according to your individual requirements. The grandstand seats can be easily attached to the aluminium frame with just three screws. This modular system makes an enormous variety of colours possible, e.g. club colours. The frame is made of natural aluminium and is equipped with a sturdy cross strut. The bench is UV-resistant and absolutely weatherproof thanks to the water drainage on the seat shells. Thanks to its low weight, the bench is easy to transport. Screws for fastening and cover caps are included.

Height: 900 cm Width: 450 cm Length: 1960 cm  
No. 41221 black



### Advertising referee chair Court Royal Deluxe Grand-Slam

The heavy-duty tennis chair is completely clad with 10 mm PVC panels. The advertising panels between the steps are made of 3 mm PVC. The aluminium base frame is plastic-coated. UV-resistant plastic bucket seat, PVC writing board. Available colours white, black and green, without advertising imprint.

No. 408103 black

### Labelling with 4-colour digital printing

If a printable file is provided.  
No. 407934

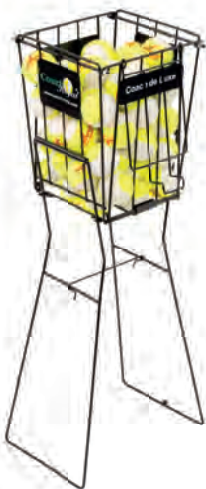

### Ball basket Court Royal Black Series

The best-selling ball basket, tried and tested for 30 years. Very sturdy ball basket, for collecting balls without bending down and can be set up using the folding bracket, lockable lid without lock.

Standing height 88 cm, capacity 60 balls, weight 2.8 kg.  
No. 42080



### Ball trolley Black Series

This ball trolley leaves nothing to be desired. The Easy Pack ball trolley with removable bag for 120 balls and a sturdy, mobile aluminium frame can be easily folded and stored in the smallest of spaces.

No. 42054



### Ball trolley Court Royal Black Series

Very stable ball trolley, easy to manoeuvre thanks to large guide rollers. Large ball basket and extra storage basket. The frame, baskets and lockable lid, without lock, are powder-coated in black. Basket height 95 cm, basket size [LxWxH] 60 x 49 x 36 cm, capacity

330 balls, weight: 10 kg.  
No. 43021